



微信公众平台：海利普变频器



## HLP-P Series Instruction



## HLP-P Series



## Contents

|   |    |
|---|----|
| . Introduction                                  | 1  |
| 1. Checks upon Delivery                         | 2  |
| 2. Nameplate Description of HLP Series Inverter | 3  |
| . Safety Precautions                            | 4  |
| 1. Before the Power-up                          | 4  |
| 2. During the Power-up                          | 6  |
| 3. During the Operation                         | 6  |
| . Standards and Specifications                  | 7  |
| 1. Particular Specifications                    | 7  |
| 2. General Specifications                       | 8  |
| . Storage and Installation                      | 10 |
| 1. Storage                                      | 10 |
| 2. Installation Site and Environment            | 10 |
| 3. Installation and Direction                   | 10 |
| . Wiring  | 12 |
| 1. Main Circuit Wiring Schematic Diagram        | 12 |
| 2. Description of Terminal Block                | 13 |
| 3. Basic Connection Diagram                     | 15 |
| 4. Precautions on Wiring                        | 18 |
| .VI.Instruction of the Digital Operator         | 21 |
| 1.Description of the Digital Operator           | 21 |



|  |           |
|--|-----------|
| 2. Description of the panel type                                       | 22        |
| 3. List of the panel used in inverter                                  | 22        |
| 4. Description of Indicator Lamp Status                                | 23        |
| 5. Description of Operation Examples                                   | 24        |
| <b>. Commissioning</b>   | <b>25</b> |
| 1. Important Checks before the Commissioning                           | 25        |
| 2. Commissioning Methods   | 25        |
| <b>. Function List</b>   | <b>26</b> |
| <b>. Descriptions of Functions</b>                                     | <b>33</b> |
| <b>. Care &amp; Maintenance, Fault Information and Troubleshooting</b> | <b>83</b> |
| 1. Precautions about Inspection and Maintenance                        | 83        |
| 2. Periodical Inspection and Maintenance items                         | 83        |
| 3. Fault Indication and Troubleshooting                                | 84        |
| 4. Faults and Analysis   | 86        |
| <b>. Selection of Peripheral Devices and Disposition</b>               | <b>89</b> |
| 1. Options   | 89        |
| 2. Disposition   | 90        |
| <b>. Appendices</b>  | <b>94</b> |
| Appendix 1 : Simple Examples of Application                            | 94        |
| Appendix 2: Appearance and Installation Dimensions                     | 101       |
| Appendix 3: Appearance and Installation Dimensions                     | 105       |
| Appendix 4: Description of Parameter Setting for HLP-P Inverter        | 106       |
| Appendix 5: User's Records and Feedback                                | 108       |

## I. Introduction

Thank you for purchasing and using the general-purpose inverter of HLP-P series of multi-functions and high performance.

Please read carefully the operation manual before putting the inverter to use so as to correctly install and operate the inverter, give full play to its functions and ensure the safety. Please keep the operation manual handy for future reference, maintenance, inspection and repair.

Due to the inverter of a kind of electrical and electronic product it must be installed, tested and adjusted with parameters by specialized engineering persons of motors.

The marks of  **Danger**  **Caution** and other symbols in the manual remind you of the safety and prevention cautions during the handling, installation, running and inspection. Please follow these instructions to make sure the safe use of the inverter. In case of any doubt please contact our local agent for consultation. Our professional persons are willing and ready to serve you.

The manual is subject to change without notice.

 **Danger** indicates wrong use may kill or injure people.

 **Caution** indicates wrong use may damage the inverter or mechanical system.

 **Danger**

- Be sure to turn off the input power supply before wiring.
- Do not touch any internal electrical circuit or component when the charging lamp is still on after the AC power supply is disconnected, which means the inverter still has high voltage inside and it is very dangerous.
- Do not check components and signals on the circuit boards during the operation.
- Do not disassemble or modify any internal connecting cord, wiring or component of the inverter by yourself.
- Be sure to make correct ground connection of the earth terminal of the inverter.
- Never remodel it or exchange control boards and components by yourself. It may expose you to an electrical shock or explosion, etc.



- Do not make any voltage-withstanding test with any component inside the inverter. These semi-conductor parts are subject to the damage of high voltage.
- Never connect the AC main circuit power supply to the output terminals U.V W of the inverter.
- The main electric circuit boards of CMOS and IC of the inverter are subject to the effect and damage of static electricity. Don't touch the main circuit boards.
- Installation, testing and maintenance must be performed by qualified professional personnel.
- The inverter should be discarded as industrial waste. It is forbidden to burn it.

## 1. Checks upon Delivery

The inverter has been strictly and well packed before ex-work. In consideration of various factors during the transportation special attention should be paid to the following points before the assembly and installation. If there is anything abnormal please notify the dealer or the relevant people of our company.

- Check if the inverter has got any damage or deformation during the transportation and handling.
- Check if there is one piece of HLPseries inverter and one copy of the instruction manual available when unpacking it.
- Check the information on the nameplate to see if the specifications meet your order (Operating voltage and KVA value).
- Check if there is something wrong with the inner parts, wiring and circuit board.
- Check if each terminal is tightly locked and if there is any foreign article inside the inverter.
- Check if the operator buttons are all right.
- Check if the optional components you ordered are contained.
- Check if there is a certificate of qualification and a warranty card.

## 2. Nameplate Description of HLP Series Inverter

|                             |                   |
|-----------------------------|-------------------|
| MODEL:                      | HLPP07D543B       |
| INPUT:                      | 3PH380V50Hz       |
| OUTPUT:                     | 3PH380V17.5A7.5KW |
| Freq-Range:                 | 0.1~400Hz         |
| HOLIP ELECTRONICS CO., LTD. |                   |

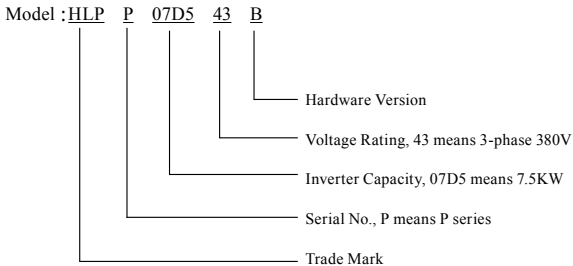



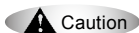

## II. Safety Precautions

### 1. Before the Power-up



- Check to be sure that the voltage of the main circuit AC power supply matches the input voltage of the inverter.
- The symbol, , represents ground terminals. Be sure to make correct ground connection of the earth terminals of the motor and the inverter for safety.
- No contactor should be installed between the power supply and the inverter to be used for starting or stopping of the inverter. Otherwise it will affect the service life of the inverter.



- R.S.T terminals are power input terminals, never mixed with U.V.W terminals. Be sure that the wiring of the main circuit is correct. Otherwise it will cause damages of the inverter when the power is applied to it.
- The terminal of  must be grounded separately and never connected to line zero. Otherwise it will easily cause the protection or errors of the inverter.



- Do not carry the front cover of the inverter directly when handling. It should be handled with the base to prevent the fall-off of the front cover and avoid the dropping of the inverter, which may possibly cause the injuries to people and the damages to the inverter.
- Mount the inverter on a metal or other noncombustible material to avoid the risk of fire.
- Install the inverter in a safe location, avoiding high temperature, direct sunlight, humid air or water.
- Keep the inverter from the reach of children or persons not concerned.
- The inverter can only be used at the places accredited by our company. Any unauthorized working environment may have the risks of fire, gas explosion, electric shock and other incidents.
- Install a heat sink or other cooling device when installing more than

one inverter in the same enclosure so that the temperature inside the enclosure be kept below 40 °C to avoid overheat or the risk of fire.

- Be sure to turn off the power supply before disassembling or assembling the operation keypad and fixing the front cover to avoid bad contact causing faults or non-display of the operator.
- Do not install the inverter in a space with explosive gas to avoid the risk of explosion.
- If the inverter is used at or above 1000m above seal level, the cooling efficiency will be worse, so please run it by de-rating.
- Do not install any contactor and other components of capacitor or varistor on the output side of the inverter. Otherwise it will cause malfunctions and damages of components of the inverter.
- Do not install any switch component like air circuit breaker or contactor at the output of the inverter. If any of such components must be installed because of the requirements of process and others, it must be ensured that the inverter has no output when the switch acts. In addition, it is forbidden to install any capacitor for improvement of power factor or any varistor against thunder at the output. Otherwise it will cause malfunctions, tripping protection and damages of components of the inverter. Please remove them as shown in the below diagram.
- It will affect the service life of the inverter if a contact is connected to the front end of input of the inverter to control its starts and stops. Generally it is required to control it through FOR or REV terminals. Special attention should be paid to its use in the case of frequent starts and stops.
- Please use an independent power supply for the inverter. Do avoid using the common power supply with an electrical welder and other equipment with strong disturbance. Otherwise it will cause the protection or even damage of the inverter.

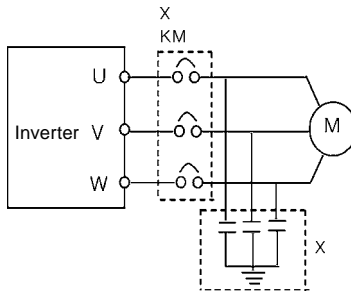

## 2. During the Power-up

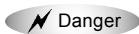

- Do not plug the connectors of the inverter during the power up to avoid any surge into the main control board due to plugging, which might cause the damage of the inverter.
- Always have the protective cover in place before the power up to avoid electrical shock injury.

## 3. During the Operation

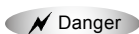

- Never connect or disconnect the motor set while the inverter is in running. Otherwise it will cause over-current trip and even burn up the main circuit of the inverter.
- Never remove the front cover of the inverter while the inverter is powered up to avoid any injury of electric shock.
- Do not come close to the machine when the fault restart function is used to avoid anything unexpected. The motor may automatically restart after its stop.
- The function of STOP Switch is only valid after setting, which is different with the use of emergent stop switch. Please pay attention to it when using it.



- Do not touch the heat sink, braking resistor, or other heat elements. These can become very hot.
- Be sure that the motor and machine is within the applicable speed ranges before starting operation because the inverter is quite easy to run from lower speed to higher speed.
- Do not check the signals on circuit boards while the inverter is running to avoid danger.
- Be careful when changing the inverter settings. The inverter has been adjusted and set before ex-work. Do not adjust it wantonly. Please make proper adjustments according to the required functions.
- Do consider the vibration, noise and the speed limit of the motor bearings and the mechanical devices when the inverter is running at or above the frequency of 50Hz.

The user must strictly follow the instruction to operate and make wire connection. Otherwise HOLIP will not responsible for the damages due to wrong operation. The user will responsible for the damages themselves.

### III. Standards and Specifications

#### 1. Particular Specifications

| Type        | Input Voltage                     | Power (KW) | Inverter Capacity (KVA) | Output Current (A) | Suitable Motor (KW) |
|-------------|-----------------------------------|------------|-------------------------|--------------------|---------------------|
| HLPP0D7523C | Single & Three phase<br>220V 50HZ | 0.75       | 2.0                     | 5.0                | 0.75                |
| HLPP01D523C | Single & Three phase<br>220V 50HZ | 1.5        | 2.8                     | 7.0                | 1.5                 |
| HLPP02D223C | Single & Three phase<br>220V 50HZ | 2.2        | 4.4                     | 11                 | 2.2                 |
| HLPP03D723B | Single & Three phase<br>220V 50HZ | 3.7        | 6.8                     | 17                 | 3.7                 |
| HLPP05D523B | Single & Three phase<br>220V 50HZ | 5.5        | 10                      | 25                 | 5.5                 |
| HLPP0D7543C | 3Φ380V 50Hz                       | 0.75       | 2.2                     | 2.7                | 0.75                |
| HLPP01D543C | 3Φ380V 50Hz                       | 1.5        | 3.2                     | 4.0                | 1.5                 |
| HLPP02D243C | 3Φ380V 50Hz                       | 2.2        | 4.0                     | 5.0                | 2.2                 |
| HLPP03D743C | 3Φ380V 50Hz                       | 3.7        | 6.8                     | 8.5                | 3.7                 |
| HLPP05D543B | 3Φ380V 50Hz                       | 5.5        | 10                      | 12.5               | 5.5                 |
| HLPP07D543B | 3Φ380V 50Hz                       | 7.5        | 14                      | 17.5               | 7.5                 |
| HLPP001143B | 3Φ380V 50Hz                       | 11         | 19                      | 24                 | 11                  |
| HLPP001543B | 3Φ380V 50Hz                       | 15         | 26                      | 33                 | 15                  |
| HLPP18D543B | 3Φ380V 50Hz                       | 18.5       | 32                      | 40                 | 18.5                |
| HLPP002243B | 3Φ380V 50Hz                       | 22         | 37                      | 47                 | 22                  |
| HLPP003043B | 3Φ380V 50Hz                       | 30         | 52                      | 65                 | 30                  |
| HLPP003743B | 3Φ380V 50Hz                       | 37         | 64                      | 75                 | 37                  |
| HLPP004543B | 3Φ380V 50Hz                       | 45         | 72                      | 91                 | 45                  |
| HLPP005543B | 3Φ380V 50Hz                       | 55         | 84                      | 110                | 55                  |
| HLPP007543B | 3Φ380V 50Hz                       | 75         | 116                     | 152                | 75                  |
| HLPP009043B | 3Φ380V 50Hz                       | 90         | 134                     | 176                | 90                  |

|             |             |     |     |     |     |
|-------------|-------------|-----|-----|-----|-----|
| HLPP011043B | 3Φ380V 50Hz | 110 | 160 | 210 | 110 |
| HLPP013243B | 3Φ380V 50Hz | 132 | 193 | 253 | 132 |
| HLPP016043B | 3Φ380V 50Hz | 160 | 230 | 304 | 160 |
| HLPP018543B | 3Φ380V 50Hz | 185 | 260 | 340 | 185 |
| HLPP020043B | 3Φ380V 50Hz | 200 | 290 | 380 | 200 |
| HLPP022043B | 3Φ380V 50Hz | 220 | 325 | 426 | 220 |
| HLPP025043B | 3Φ380V 50Hz | 250 | 381 | 480 | 250 |
| HLPP028043B | 3Φ380V 50Hz | 280 | 427 | 560 | 280 |
| HLPP030043B | 3Φ380V 50Hz | 300 | 450 | 580 | 300 |
| HLPP031543B | 3Φ380V 50Hz | 315 | 460 | 605 | 315 |
| HLPP034543B | 3Φ380V 50Hz | 345 | 502 | 660 | 345 |
| HLPP037543B | 3Φ380V 50Hz | 375 | 544 | 715 | 375 |
| HLPP040043B | 3Φ380V 50Hz | 400 | 582 | 765 | 400 |
| HLPP041543B | 3Φ380V 50Hz | 415 | 604 | 795 | 415 |
| HLPP045043B | 3Φ380V 50Hz | 450 | 664 | 880 | 450 |

## 2. General Specifications

|  |   |   |
|--|---|---|
| Inverter Series                          | HLP-P   |   |
| Control Mode                             | SPWM  |   |
| Input Power                              | 380±15% for 380V power; 220±15% for 220V power  |   |
| 5-Digits Display & Status Indicator Lamp | Displaying frequency, current, revolution, voltage, counter, temperature, forward or reserve running, and fault, etc. |   |
| Communication Control                    | RS-485  |   |
| Operation Temperature                    | -10~40℃   |   |
| Humidity                                 | 0-95% Relative Humidity (without dew)   |   |
| Vibration                                | Below 0.5G  |   |
| Frequency Control                        | Range   | 0.10~400.00Hz   |
|  | Accuracy  | Digital:0.01%(-10~40℃), Analog:0.1% (25±10)   |
|  | Setting Resolution  | Digital:0.01Hz, Analog:1% of Max. Operating Frequency   |
|  | Output Resolution   | 0.01Hz  |
|  | Operator Setting Method   | Press directly <input type="checkbox"/> <input type="checkbox"/> <input type="checkbox"/> to set. |
|  | Analog Setting Method   | External Voltage 0-5V, 0-10V, 4-20mA, 0-20mA.   |

|                      |                          |  |
|----------------------|--------------------------|--|
|                      | Other Functions          | Frequency lower limit, starting frequency, stopping frequency, three skip frequencies can be respectively set.   |
| General Control      | Ramp Control             | Selectable 4-speed steps ramp-up and -down time (0.1-6500s).   |
|                      | V/F Curve                | Set V/F curve at will  |
|                      | Torque Control           | Torque increase is settable by max. 10.0%. The starting torque can reach 150% at 1.0Hz.  |
|                      | Multi-Inputs             | 6 multi-function input terminals for 8-speed steps control, program operation, switching of 4-speed Ramp, UP/DOWN function, counter, external emergency stop and other functions.  |
|                      | Multi-Outputs            | 5 multi-function output terminals for displaying of running, zero speed, counter, external abnormality, program operation and other information and warnings.  |
|                      | Other Functions          | AVR (auto voltage regulation), Deceleration stop or free-stop, DC brake, auto reset and restart, frequency track, PLC control, traverse function, drawing control, auto energy-savings, carrier adjustable by max. 16KHz, etc. |
| Protection Functions | Overload Protection      | Electronic relay protection motor Drive (for constant torque 150%/1 min. for the kinds of fan 120%/1min.)  |
|                      | FUSE Protection          | FUSE broken, Motor stops.  |
|                      | Over-voltage             | DC Voltage >400V for 220V class<br>DC Voltage >800V for 380V class   |
|                      | Low Voltage              | DC Voltage <200V for 220V class<br>DC Voltage <400V for 380V class   |
|                      | Instant Stop and Restart | Restarted by frequency track after instantaneous stop.   |
|                      | Stall Prevention         | Anti-stall during Acc/Dec run  |
|                      | Output End Shorts        | Electronic circuit protecting  |
|                      | Other Functions          | Fin over-heat protection, restriction of reverse running, direct start after power on, fault reset, parameter lock PID, one-drive-more, etc.   |

## IV. Storage and Installation

### 1. Storage

The inverter must be kept in its original package box before installation. Pay attention to the followings when keeping it in storage if the inverter is not used for the time being:

- It must be stored in a dry place without rubbish or dust.
- The suitable temperature for storage is between  $-20^{\circ}\text{C}$  and  $+65^{\circ}\text{C}$ .
- The relative humidity required is 0-95% without condensation.
- There is no corrosive gas or liquid in the storage ambience.
- It's better to lay the inverter on a rack and keep it in a proper package.
- It is better not to store the inverter for long time. Long time storage of the inverter will lead to the deterioration of electrolytic capacity. If it needs to be stored for a long time make sure to power it up one time within a year and the power-up time should be at least above five hours. When powered up the voltage must be increased slowly with a voltage regulator to the rated voltage value.

### 2. Installation Site and Environment

The inverter should be installed at the following location:

- Ambient temperature  $-5^{\circ}\text{C}$  to  $40^{\circ}\text{C}$  with good ventilation.
- No water drop and low moisture.
- Free from direct sunshine, high temperature and heavy dust fall.
- Free from corrosive gas or liquid.
- Less dust, oil gas and metallic particles
- Free from vibration and easy for service and inspection.
- Free from the interference of electromagnetic noise.

Attention: The ambient conditions of the inverter will affect its service life.

### 3. Installation and Direction

- There must be enough space left around the inverter for easy maintenance and cooling. See Diagram 1.
- The inverter must be installed vertically with the smooth ventilation for effective cooling.
- If there is any instability when installing the inverter, please put a flat board under the inverter bottom base and install it again. If the inverter is installed on a loose surface, stress may cause damage of parts in the main circuit so as to damage the inverter.
- The inverter should be installed on non-combustible materials, such

as iron plate.

- If several inverters are installed, upper and lower, together in one cabinet, please add heat dissipation plates and leave enough space between the inverters. See Diagram.

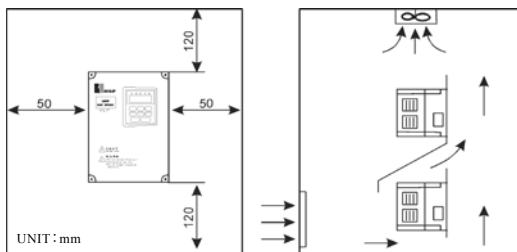



## V. Wiring

### 1. Main Circuit Wiring Schematic Diagram



Power supply:

- Verify that the inverter's rated voltage coincides with AC power supply voltage to avoid a damage of the inverter



No fuse breaker:

- Refer to the related list
- Ground fault circuit interrupter:
- Use one of anti-high harmonic



Electromagnetic contactor:

- Note: Do not use the electromagnetic contactor as the on/off button of power supply for the inverter



AC reactor:

- It is recommended to install an AC reactor for power factor improvement if the input capacity is more than 1000KVA.



Inverter:

- Be sure to make correct connections of the main circuit wires and control signal wires of the inverter.
- Be sure to make correct setting of parameters for the inverter.



## 2. Description of Terminal Block

### 1) Arrangement of Main circuit Terminals

HLPP0D7523C~  
HLPP02D223C  
HLPP0D7543C~  
HLPP03D743C

|   |   |   |   |   |   |   |    |    |   |
|---|---|---|---|---|---|---|----|----|---|
|   |   |   |   |   |   |   |    |    |   |
| E | R | S | T | U | V | W | P+ | PR |   |
| ⊕ | ⊕ | ⊕ | ⊕ | ⊕ | ⊕ | ⊕ | ⊕  | ⊕  | ⊕ |

HLPP05D543B  
HLPP03D723B~  
HLPP05D523B

|   |   |   |   |   |   |   |   |    |   |
|---|---|---|---|---|---|---|---|----|---|
|   |   |   |   |   |   |   |   |    |   |
| E | R | S | T | U | V | W | P | PR |   |
| ⊕ | ⊕ | ⊕ | ⊕ | ⊕ | ⊕ | ⊕ | ⊕ | ⊕  | ⊕ |

HLPP07D543B~  
HLPP001143B

|   |   |   |   |   |   |   |   |   |    |
|---|---|---|---|---|---|---|---|---|----|
|   |   |   |   |   |   |   |   |   |    |
| E | R | S | T | U | V | W | N | P | PR |
| ⊕ | ⊕ | ⊕ | ⊕ | ⊕ | ⊕ | ⊕ | ⊕ | ⊕ | ⊕  |

HLPP001543B~  
HLPP003743B

|   |   |   |   |   |   |   |   |   |   |
|---|---|---|---|---|---|---|---|---|---|
|   |   |   |   |   |   |   |   |   |   |
| R | S | T | E | P | N | U | V | W |   |
| ⊕ | ⊕ | ⊕ | ⊕ | ⊕ | ⊕ | ⊕ | ⊕ | ⊕ | ⊕ |

HLPP004543B~  
HLPP018543B

|   |   |   |   |   |    |   |   |   |   |
|---|---|---|---|---|----|---|---|---|---|
|   |   |   |   |   |    |   |   |   |   |
| R | S | T | E | P | P1 | N | U | V | W |
| ⊕ | ⊕ | ⊕ | ⊕ | ⊕ | ⊕  | ⊕ | ⊕ | ⊕ | ⊕ |



|                |   |   |   |   |   |   |   |   |   |
|----------------|---|---|---|---|---|---|---|---|---|
| P <sub>1</sub> | + | - | R | S | T | E | U | V | W |
| ⊕              | ⊕ | ⊕ | ⊕ | ⊕ | ⊕ | ⊕ | ⊕ | ⊕ | ⊕ |

Cabinet HLPP016043BG-HLPP045043B

### 2) Arrangement of Control Circuit Terminals

|  |    |    |     |      |      |     |     |     |     |     |     |
|--|----|----|-----|------|------|-----|-----|-----|-----|-----|-----|
| COM  |    | AO |     | GND  |      | RI  |     | VCC |     |     |     |
| HLPP001543B ~ HLPP045043B                              |    |    |     |      |      |     |     |     |     |     |     |
| FA   | FB | FC |     | +12V | SPL  | SPM | SPH | RST | DCM | REV | FOR |
| KA   | KB |    | UPF | AO   | +10V | VI  | AI  | ACM | VO  | RS- | RS+ |
| HLPP0D7523C ~ HLPP02D223C    HLPP0D7543C ~ HLPP03D743C |    |    |     |      |      |     |     |     |     |     |     |

|    |    |    |    |    |      |     |     |     |     |     |
|----|----|----|----|----|------|-----|-----|-----|-----|-----|
| FA | FB | FC | KA | KB | +12V | UPF | DCM | SPL | SPM | SPH |
|----|----|----|----|----|------|-----|-----|-----|-----|-----|

|     |     |     |     |    |    |     |    |    |     |     |
|-----|-----|-----|-----|----|----|-----|----|----|-----|-----|
| RST | REV | FOR | +10 | VI | AI | ACM | AO | VO | RS+ | RS- |
|-----|-----|-----|-----|----|----|-----|----|----|-----|-----|

HLPP03D723B~HLPP05D523B HLPP05D543B ~HLPP001143B

|    |    |    |    |    |    |     |     |     |     |     |
|----|----|----|----|----|----|-----|-----|-----|-----|-----|
| FA | FB | FC | KA | KB | EV | UPF | DRV | DCM | SPL | SPM |
|----|----|----|----|----|----|-----|-----|-----|-----|-----|

|     |     |     |     |     |    |    |     |    |     |     |
|-----|-----|-----|-----|-----|----|----|-----|----|-----|-----|
| SPH | RST | REV | FOR | +10 | VI | AI | ACM | AM | RS- | RS+ |
|-----|-----|-----|-----|-----|----|----|-----|----|-----|-----|

HLPP001543B~HLPP045043B

### 3)Function Description of Main circuit Terminals

| Symbol      | Function Description   |
|-------------|--|
| R.S.T       | Input terminal of AC line power. (220V class, for both single/three phase, single phase connected to any two phases)           |
| U.V.W       | Output terminal of the inverter  |
| P.Pr        | Connector for braking resistor.  |
| PIP         | Connector for DC reactor (When using a DC reactor the jumper shall be removed. P07D543B and P001143B internally jumped)        |
| P(+), N (-) | Connecting terminal of external braking bank.  |
| E           | Ground terminal: the third method of grounding for 220V and special grounding for 380 V of Electrical Engineering Regulations. |

### 4) Function Description of Control Circuit Terminals

| Symbol    | Function Description   | Factory setting           |
|-----------|--|---------------------------|
| FOR       | Multi-Input 1  | Forward run               |
| REV       | Multi-Input 2  | Reverse run               |
| RST       | Multi-Input 3  | Reset                     |
| SPH       | Multi-Input 4  | High speed                |
| SPM       | Multi-Input 5  | Middle Speed              |
| SPL       | Multi-Input 6  | Low Speed                 |
| DCM       | Common Terminal of Digital and Control Signals, +12v Power (EV) Ground |                           |
| EV+ (12V) | +12V Power Supply  | Max. output current 200mA |
| P24       | +12V Power Supply  | Max. output current 200mA |
| +10       | Power Supply for Speed Setting   | +10V                      |

| Symbol  | Function Description                          | Factory setting   |
|---------|---|---|
| VI      | Analog Voltage Frequency Reference Input      | 0~+10V corresponding to the highest operating frequency |
| AI      | Analog Current Frequency Reference Input      | 4~20mA corresponding to the highest operating frequency |
| AO      | Output current                                |   |
| VO      | Output voltage                                |   |
| ACM     | Common Terminal of Analog and Control Signals |   |
| DRV     | Multi-Output 1 (Optical couple output)        | DC24V/100mA   |
| UPF     | Multi-Output 2 (Optical couple output)        |   |
| FA      | Multi-Output 3 (N/O or N/C)                   | 3A/250VAC、3A/30VDC                                      |
| FB      |   |   |
| FC      |   |   |
| KA      | Multi-Output 4 (N/O)                          | 3A/250VAC、3A/30VDC                                      |
| KB      |   |   |
| AM/VO   | Output terminals of digital frequency         | 0~10V   |
| RS+ RS- | RS485 Communication port                      |   |

### 3. Basic Connection Diagram

The wiring of the inverter is divided into two parts, main circuit terminal connections and control circuit terminal connections. The user can see the main circuit terminals, and the control circuit terminals after removing the cover of enclosure. The terminals must be connected correctly as the following wiring circuit diagrams.

The following diagram shows the factory standard connection of Model HLP-P

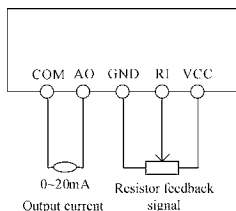

HLP001543B ~ HLPP045043B

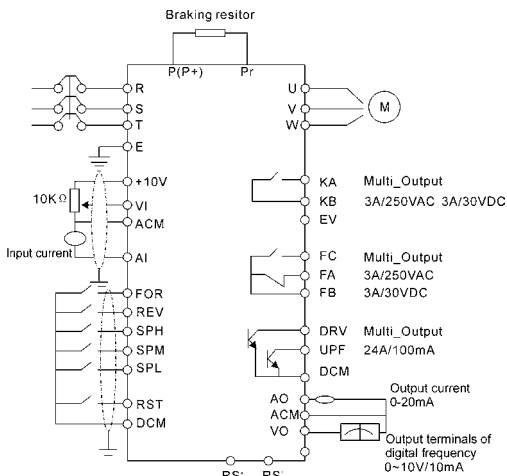

HLPP0D7523C ~ HLPP05D523B HLPP01D543C ~ HLPP05D543B

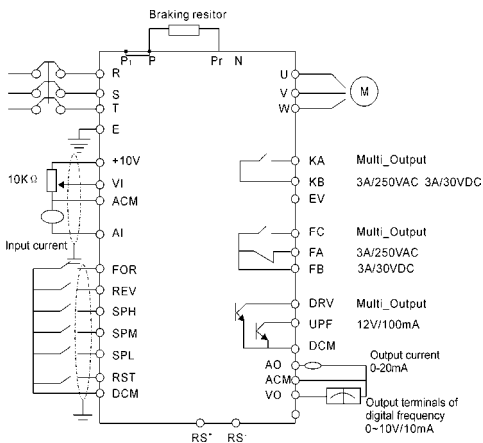

HLPP07D543B ~ HLPP001143B

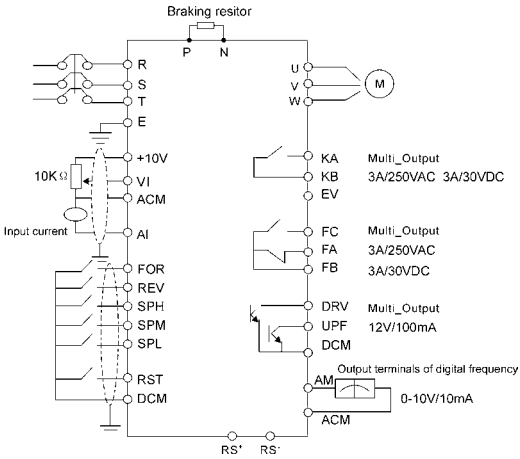

HLPP001543B~HLPP003743B

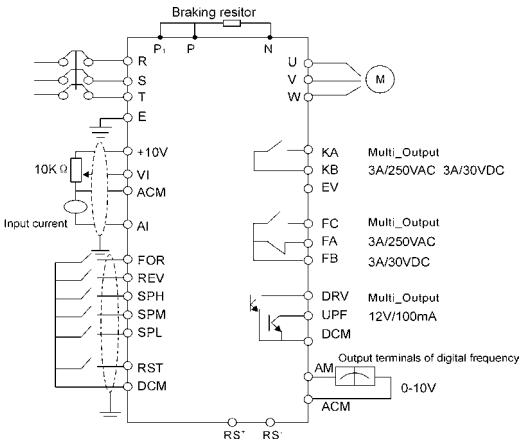

HLPP004543B~HLPP0045043

#### 4. Precautions on Wiring

1) For the main circuit wiring:

- While wiring the sizes and specifications of wires should be selected and the wiring should be executed according to the electrical engineering regulations to ensure the safety.
- It is better to use shielded wire or wire and conduit for power cord and ground the shielded layer or two ends of wire conduit.
- Be sure to install a Non Fuse Breaker (NFB) between the power supply and the input terminals (R.S.T). (If using ground fault circuit interrupter, please choose one corresponding to high frequency)
- Never connect AC power to the output terminal (U.V.W) of the inverter.
- Output wires mustn't be in touch of the metal part of the inverter enclosure, or it will result in earth short-circuit.
- Phase-shifting capacitors, LC, RC noise filters, etc, can never be connected to the output terminals of the inverter.
- The main circuit wire must be enough far away from other control equipments.
- When the wiring between the inverter and the motor exceeds 15 meters for 220V class or 30 meters for 380V class, much higher dV/dT will be produced inside the coil of the motor, which will cause the destruction to the interlay or insulation of the motor. Please use a dedicated AC motor for the inverter or add a reactor at the inverter.
- Please lower the carrier frequency when there is a longer distance between the inverter and the motor. Because the higher the carrier frequency is the bigger the leakage current of high-order harmonics in the cables will be. The leakage current will have unfavorable effect on the inverter and other equipment.

#### Specifications of Non Fuse Breaker and Wire

| Model       | NFB(A) | Input wire<br>mm <sup>2</sup> | Output<br>wire mm <sup>2</sup> | Control<br>wire mm <sup>2</sup> | Screw |
|-------------|--------|-------------------------------|--------------------------------|---------------------------------|-------|
| HLPP0D7523C | 16     | 2.5                           | 2.5                            | 1                               | M4    |
| HLPP01D523C | 16     | 2.5                           | 2.5                            | 1                               | M4    |
| HLPP02D223C | 32     | 2.5                           | 2.5                            | 1                               | M5    |
| HLPP03D723B | 40     | 6                             | 6                              | 1                               | M6    |
| HLPP05D523B | 40     | 6                             | 6                              | 1                               | M6    |
| HLPP0D7543C | 16     | 2.5                           | 25                             | 1                               | M4    |
| HLPP01D543C | 16     | 2.5                           | 2.5                            | 1                               | M4    |
| HLPP02D243C | 16     | 2.5                           | 2.5                            | 1                               | M4    |
| HLPP03D743C | 16     | 2.5                           | 2.5                            | 1                               | M4    |

| Model       | NFB(A) | Input wire<br>mm <sup>2</sup> | Output<br>wire mm <sup>2</sup> | Control<br>wire mm <sup>2</sup> | Screw |
|-------------|--------|-------------------------------|--------------------------------|---------------------------------|-------|
| HLPP05D543B | 16     | 2.5                           | 2.5                            | 1                               | M4    |
| HLPP07D543B | 32     | 4                             | 4                              | 1                               | M4    |
| HLPP001143B | 40     | 6                             | 6                              | 1                               | M5    |
| HLPP001543B | 63     | 6                             | 6                              | 1                               | M6    |
| HLPP18D543B | 63     | 6                             | 6                              | 1                               | M6    |
| HLPP002243B | 100    | 10                            | 10                             | 1                               | M6    |
| HLPP003043B | 100    | 16                            | 16                             | 1                               | M8    |
| HLPP003743B | 160    | 25                            | 25                             | 1                               | M8    |
| HLPP004543B | 160    | 25                            | 25                             | 1                               | M8    |
| HLPP005543B | 200    | 35                            | 35                             | 1                               | M10   |
| HLPP007543B | 200    | 35                            | 35                             | 1                               | M10   |
| HLPP009043B | 250    | 70                            | 70                             | 1                               | M10   |
| HLPP011043B | 315    | 70                            | 70                             | 1                               | M10   |
| HLPP013243B | 400    | 95                            | 95                             | 1                               | M12   |
| HLPP016043B | 400    | 150                           | 150                            | 1                               | M12   |
| HLPP018543B | 630    | 185                           | 185                            | 1                               | M12   |
| HLPP020043B | 630    | 240                           | 240                            | 1                               | M16   |
| HLPP022043B | 630    | 240                           | 240                            | 1                               | M16   |
| HLPP025043B | 800    | 150×2                         | 150×2                          | 1                               | M16   |
| HLPP028043B | 800    | 150×2                         | 150×2                          | 1                               | M16   |
| HLPP030043B | 800    | 150×2                         | 150×2                          | 1                               | M16   |
| HLPP031543B | 800    | 150×2                         | 150×2                          | 1                               | M16   |
| HLPP034543B | 1000   | 185×2                         | 150×2                          | 1                               | M16   |
| HLPP037543B | 1000   | 185×2                         | 150×2                          | 1                               | M16   |
| HLPP040043B | 1200   | 240×2                         | 185×2                          | 1                               | M16   |
| HLPP041543B | 1200   | 240×2                         | 185×2                          | 1                               | M16   |
| HLPP045043B | 1200   | 240×2                         | 185×2                          | 1                               | M16   |

2)For control circuit wiring (signal line)

- The signal line should be separately laid in a different conduit with the main circuit wire to avoid any possible interference.
- Please use the shielded cable with the size of 0.5-2mm<sup>2</sup> for signal lines.
- Use the control terminals on the control panel correctly according to your needs.

3)Grounding

- Grounding terminal E. Be sure to make correct grounding  
220V class: The third grounding method (Grounding resistance



should be  $100\Omega$  or lower.)

380V class: The special third grounding method (Grounding resistance should be  $10\Omega$  or lower.)

- Choose grounding wires according to the basic length and size of the technical requirements of the electric equipment.
- Do avoid sharing grounding wire with other large power equipment such as electric welder, power machine, etc. The grounding wire should be kept away from the power supply wires for large power equipment.
- The grounding method for several inverters together should be done as the first and second diagrams below. Avoid the third loop.
- The grounding wire must be as shorter as possible.

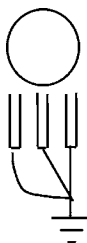

(1) Good



(2) Good

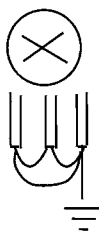

(3) Not good

## VI. Instruction of the Digital Operator

### 1. Description of the Digital Operator

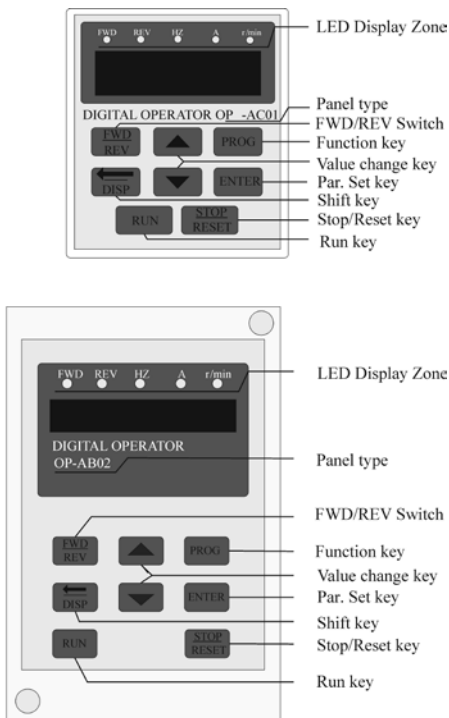

Note:

The inverter of the hardware version C can use the panel OP-AC01, the inverter of the hardware version B can use the panel OP-AB01 or OP-AB02.

The panel OP-AB01 and OP-AB02 have the same function, but different size, You can see the size in the appendix 3.

## 2. Description of the panel type

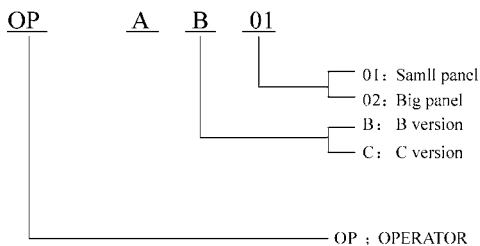

## 3. List of the panel used in inverter

| Model       | Specification | Panel type |
|-------------|---------------|------------|
| HLPP0D7523C | 0.75KW/220V   | OP-AC01    |
| HLPP01D523C | 1.5KW/220V    | OP-AC01    |
| HLPP02D223C | 2.2KW/220V    | OP-AC01    |
| HLPP03D723B | 3.7KW/220V    | OP-AB01    |
| HLPP05D523B | 5.5KW/220V    | OP-AB01    |
| HLPP0D7543C | 0.75KW/380V   | OP-AC01    |
| HLPP01D543C | 1.5KW/380V    | OP-AC01    |
| HLPP02D243C | 2.2KW/380V    | OP-AC01    |
| HLPP03D743C | 3.7KW/380V    | OP-AC01    |
| HLPP05D543B | 5.5KW/380V    | OP-AB01    |
| HLPP07D543B | 7.5KW/380V    | OP-AB02    |
| HLPP045043B | 450KW/380V    |            |

## 4. Description of Indicator Lamp Status







### 1) Description of Indicator Lamp Status

| Indicator lamp | Status | Description                                      |
|----------------|--------|--|
| FOR            | on     | The motor is in forward rotation.                |
| REV            | on     | The motor is in reverse rotation.                |
| HZ             | on     | Displaying set frequency or output frequency.    |
| A              | on     | Displaying output current.                       |
| r/min          | on     | Displaying rated motor revolution                |
| A r/min        | on     | Displaying AC or DC voltage.                     |
| HZ r/min       | on     | Displaying counting value.                       |
| HZ A r/min     | on     | Displaying internal temperature of the inverter. |

### 2) Description of Display Items

| Display          | Indic. lamp $\times$ on | Meaning                                   |
|------------------|-------------------------|---|
| <i>T</i> 50.00   | HZ A R/min<br>○ ○ ○     | Present output frequency is 50.00HZ       |
| <i>F</i> 50.00   | HZ A R/min<br>○ ○ ○     | Present set frequency is 50.00HZ          |
| <i>R</i> 003.0   | HZ A R/min<br>○ ○ ○     | Present output current is 3.0 A           |
| <i>0</i> 1440    | HZ A R/min<br>○ ○ ○     | Present output revolution is 1440r/min    |
| $\bar{C}$ 510.1  | HZ A R/min<br>○ ○ ○     | Present DC voltage is 510.1 V             |
| $\cup$ 380.0     | HZ A R/min<br>○ ○ ○     | Present AC voltage is 380.0V              |
| $\epsilon$ 035.0 | HZ A R/min<br>○ ○ ○     | Present inverter's temperature is 35.0 °C |
| <i>0</i> 0105    | HZ A R/min<br>○ ○ ○     | Present counter's value is 105            |
| $\bar{n}$ 050.0  | HZ A R/min<br>○ ○ ○     | Present target value of PID is 50.0%      |
| $\bar{n}$ 048.0  | HZ A R/min<br>○ ○ ○     | Present feedback value of PID is 48.0%    |
| <i>0</i> 0012    | HZ A R/min<br>○ ○ ○     | Present time of power - on is 12 hours    |
| <i>0</i> 0108    | HZ A R/min<br>○ ○ ○     | Total run time of inverter is 108 hours   |

## 5. Description of Operation Examples

| Procedures                   | Display  | Indicator Lamp   | Explanation  |
|------------------------------|--|------------------|--|
| Power up, Operation of power | Dsp2.0 flash<br>Vr2.22<br>000.00   | FOR HZ<br>☐ □    | Self detect when power - up, display version no. (Flashing) and finally set frequency. |
| PROG                         | CD000  | FOR HZ<br>☐ □    | Enter programming<br>Display the function of CD000                                     |
| ENYER                        | 000.0   | FOR HZ<br>☐ □    | Display the contents of CD000  |
| ENTER                        |  0.00<br>END 50.00  | FOR HZ<br>☐ □    | Change the content of CD000<br>Confirm changed value.                                  |
| PROG                         | CD00 <br>050.  | FOR HZ<br>☐ □    | Display END 50.00 CD001<br>Back from programming                                       |
| RUN                          | 50.00  | FOR HZ<br>□ □    | Display running and operating frequency  |
| DISP                         | F50.00<br>F0.00 F5 0.00  | FOR HZ<br>□ □    | Monitor screen switching, display output current                                       |
| PROG                         | F005.0   | FOR HZ<br>□ □    | Monitor screen switching, display output current                                       |
| DISP                         | 01440  | FWD A<br>□ □     | Monitor screen switching, display revolution   |
| PROG                         | F50.00   | FOR R/min<br>□ □ | Switch back to main screen, display set frequency                                      |
| F/R                          | F50.00   | FWD HZ<br>□ □    | Switch of For.Rev. rotation, display the status of Rev rotation                        |
|                              | 050.    | FOR HZ<br>□ □    | Switch to adjustable frequency   |
|                              | 0  0.00   | FWD HZ<br>□ □    | Adjust set frequency, i.e. the value of CD000  |
| ENTER                        | 030.00   | FOR HZ<br>□ □    | Confirm changed value, write to CD000 as value   |
| STOP                         | F  0.00   | FOR HZ<br>☐ □    | Stop   |

Note: ● means flashing. □ means bright. With HLKD0001 and HLKD0002 the functions of ENTER and SET are the same, and the functions of PROG and FUNC are the same. For monitoring AC, DC, T and other items they can be only switched and displayed after the parameter setting. When it is powered up again after a power breakdown the inverter will display the screen previous to the power breakdown after its self detection.

## VII. Commissioning

### 1. Important Checks before the Commissioning

- If there is any wrong connected wires? Pay special attention to the terminal of U.V.W; Make sure the power supply wires are connected to R.S.T, not U.V.W.
- If there is any metal powder or wires left on the base plate of the inverter or the terminal block, which may cause short circuit.
- If screws are tightly locked and if the connecting parts are loose.
- If there is any short circuit or earth fault at outputs.

### 2. Commissioning Methods

The procedure of the operator is factory set up for the control mode of HLP series. The commissioning can be carried out through the digital operator. Generally, the commissioning can be conducted at 5.00 Hz.

| Procedures | Display                | Indicator Lamp | Explanation  |
|------------|------------------------|----------------|--|
| Power up   | dsp1.1 Vr2.0<br>◊◊◊◊◊◊ | FWD Hz<br>● ◻  | Self detect when power up, display version no. and finally set frequency |
|            | 050.00                 | FWD Hz<br>● ◻  | Switch to adjustable frequency on the panel                              |
|            | 050.00                 | FWD Hz<br>● ◻  | Change set frequency, i.e. the value of CD000                            |
| ENTER      | F50.00                 | FWD Hz<br>● ◻  | Confirm changed value  |
| RUN        | F50.00                 | FWD Hz<br>● ◻  | Run at 50Hz  |
| STOP       | F50.00                 | FWD Hz<br>● ◻  | Stop   |

Note: ◻ means indicator lamps is on; ● means indicator lamps flash;

◊ means digits flash.

## VII. Function List

Parameter and Function List (Part 1)

| Category              | Code     | Function                               | Set Range & Function Explanation                           | Factory Setting |
|-----------------------|----------|--|--|-----------------|
| Basic Parameters      | CD000    | Main Frequency                         | 0.00~400.00 Hz   | 0.00            |
|                       | CD001    | Max. Voltage                           | 0.1V—*   | 220/380         |
|                       | CD002    | Base Frequency                         | 0.01~400.00 Hz   | 50.00           |
|                       | CD003    | Intermediate Voltage                   | 0.1V—*   | *               |
|                       | CD004    | Intermediate Frequency                 | 0.01~400.00 Hz   | 2.50            |
|                       | CD005    | Min. Voltage                           | 0.1~50.0V  | *               |
|                       | CD006    | Min. Frequency                         | 0.01~20.00 Hz  | 0.50            |
|                       | CD007    | Max Operating Frequency                | 10.00~400.00 Hz  | 50.00           |
|                       | CD008    | Reserved                               |  |                 |
|                       | CD009    | Frequency Lower Limit                  | 0.00~400.00 Hz   | 0.00            |
|                       | CD010    | Parameter Lock                         | 0:Invalid 1:Valid  | 0               |
|                       | CD011    | Parameter Reset                        | 00~10 08:Restore the factory setting. No other function.   | 00              |
|                       | CD012    | Accel. Time 1                          | 0.1~6500.0S  | *               |
|                       | CD013    | Decel. Time 1                          | 0.1~6500.0S  | *               |
|                       | CD014    | Accel. Time 2                          | 0.1~6500.0S  | *               |
|                       | CD015    | Decel. Time 2                          | 0.1~6500.0S  | *               |
|                       | CD016    | Accel. Time 3                          | 0.1~6500.0S  | *               |
|                       | CD017    | Decel. Time 3                          | 0.1~6500.0S  | *               |
|                       | CD018    | Accel. Time 4                          | 0.1~6500.0S  | *               |
|                       | CD019    | Decel. Time 4                          | 0.1~6500.0S  | *               |
|                       | CD020    | Output Frequency at Over-voltage alarm | 00.00~*  | 5.00            |
| CD021<br>↓<br>CD030   | Reserved |  |  |                 |
| Applicable Parameters | CD031    | Starting Mode                          | 0:Start from Starting Frequency<br>1:Frequency track start | 0               |
|                       | CD032    | Stopping Mode                          | 0:Decelerating stop<br>1:Coasting stop                     | 0               |
|                       | CD033    | Source of Run Commands                 | 0:Operator 1:External terminal<br>2:Communication port     | 0               |
|                       | CD034    | Source of Operating Frequency          | 0:Operator 1:External terminal<br>2:Communication port     | 0               |
|                       | CD035    | Carrier frequency                      | 0~15   | *               |
|                       | CD036    | Jogging Frequency                      | 0.00~400.00 Hz   | 5.00            |

**Parameter and Function List (Part 2)**

| Category                   | Code                                  | Functions                | Set Range & Function Explanation   | Factory Setting |
|----------------------------|---------------------------------------|--------------------------|--|-----------------|
| Applicable Parameters      | CD037                                 | Rev. Rotation Select     | 0: Rev Run forbidden; 1: Rev Run Enable  | 1               |
|                            | CD038                                 | STOP key select          | 0: STOP Invalid 1: STOP Valid  | 1               |
|                            | CD039                                 | S-Curve Time             | 0.0~6500.0S  | 0.0             |
|                            | CD040                                 | Up/down                  | 0.01~2.50  | 0.01            |
|                            | CD041                                 | Starting Frequency       | 0.10~10.00 Hz  | 0.50            |
|                            | CD042                                 | Stopping Frequency       | 0.10~10.00 Hz  | 0.50            |
|                            | CD043                                 | Auto Torque Compensation | 0.0-10.0%  | 2.0%            |
|                            | CD044                                 | Skip Frequency 1         | 0.00~400.00 Hz   | 0.00            |
|                            | CD045                                 | Skip Frequency 2         | 0.00~400.00 Hz   | 0.00            |
|                            | CD046                                 | Skip Frequency 3         | 0.00~400.00 Hz   | 0.00            |
|                            | CD047                                 | Skip Frequency Range     | 0.10~10.00 Hz  | 0.50            |
|                            | CD048                                 | Timer 1 time             | 0.1~10.0   | 0.1             |
|                            | CD049                                 | Timer 2 time             | 1~100  | 1               |
| Input and Output Terminals | *CD050                                | Multi-input 1(FOR)       | 0: Invalid; 1: Run; 2: For rotation; 3: Rev rotation; 4: Stop; 5: FOR/REV.; 6: Jog; 7: Jog For rotation; 8: Jog Rev Rotation; 9: Emergent stop; 10: Reset; 11: Reserved; 12: Overheat of heat sink or motor; 17: High speed; Middle speed; 19: Low speed; 20: Multi-speed 1; 21: Multi-speed 2; 22: Multi-speed 3; 23: Ramp select 1; 24: Ramp select 2; 25: UP function; 26: DOWN function; 27: Counter 28: Counter reset; 29: Drawing; 32: PID Start | 02              |
|                            | *CD051                                | Multi-input 2(REV)       |  | 03              |
|                            | *CD052                                | Multi-input 3(RST)       |  | 10              |
|                            | *CD053                                | Multi-input 4(SPH)       |  | 17              |
|                            | *CD054                                | Multi-input 5(SPM)       |  | 18              |
|                            | *CD055                                | Multi-input 6(SPL)       |  | 19              |
|                            | *CD056                                | Multi-output 1(DRV)      |  | 01              |
| *CD057                     | Multi-output 2(UPF)                   |                          | 05   |                 |
| *CD058                     | Multi-output 3(Terminals of FA,FB,FC) |                          | 02   |                 |



Parameter and Function List (Part 3)

| Category                   | Code                      | Functions                          | Set Range & Function Explanation   | Factory Setting |
|----------------------------|---------------------------|------------------------------------|--|-----------------|
| Input and Output Terminals | *CD059                    | Multi-output 4(Terminals of KA,KB) | 7: Arbitrary Frequency 2 reach; 8: In Accel.; 9: In Decel.; 10: Inverter Overload alarm; 11: Motor Overload alarm; 12: Over-torque alarm; 13: Low voltage alarm; 14: Single stage end indication; 15: Process end indication; 16: Counter reach; 27: Drawing reach; 28:PID lower limit alarm; 29: PID upper limit alarm; 30: Fan act; 31: Reserved; 32: Braking resistor act | 00              |
|                            | CD060                     | Multi-output 5(AM/VO)              | Output of digital frequency signals  | 0               |
|                            | CD061                     | Uniform Frequency 1                | 0.00~400.00 Hz   | 0.00            |
|                            | CD062                     | Uniform Frequency 2                | 0.00~400.00 Hz   | 0.00            |
|                            | CD063                     | Uniform Frequency Range            | 0.10~10.00 Hz  | 0.50            |
|                            | CD064                     | Counting value set                 | 00~65500   | 00              |
|                            | CD065                     | Analog Input                       | 0:0~10V 1:0~5V<br>2:0~20mA 3:4~20mA<br>4:0~10V and 4~20mA stacked  | 0               |
|                            | CD066                     | Lower Analog Frequency             | 0.00~400.00 Hz   | 0.00            |
|                            | CD067                     | Bias Direction at Lower Frequency  | 0:Positive direction 1: Negative direction   | 0               |
|                            | CD068                     | Higher Analog Frequency            | 0.00~600.00 Hz   | 50.00           |
|                            | CD069                     | Bias Direction at Higher Frequency | 0:Positive direction 1: Negative direction   | 0               |
|                            | CD070                     | Analog Negative Bias Reverse       | 0:Not allowable. 1: Allowable.   | 0               |
|                            | CD071                     | AM Analog output Gain              | 0~100%   | 100             |
|                            | CD072                     | Up/Down Function                   | 0:Not memorized 1: Memorized   | 0               |
| CD073                      | Up/Down Speed             | 0:0.1HZ 1:0.01HZ                   | 0  |                 |
| CD074                      | Analog Filtering Constant | 0~50                               | 20   |                 |
| CD075                      | Intermediate Counter      | 0~65500                            | 0  |                 |
| Multi-speed and Simple PLC | CD076                     | PLC Operation                      | 0:Normal run; 1: External control 4 -speed; 2:External control multi-speed; 3: Disturbance; 4: Internal control multi-speed; 5: Drawing  | 0               |

**Parameter and Function List (Part 4)**

| Category                   | Code                         | Functions                               | Set Range & Function Explanation  | Factory Setting |
|----------------------------|------------------------------|---|---|-----------------|
| Multi-speed and Simple PLC | CD077                        | AutoPLC                                 | 0:Stop after running for one cycle; 1:Cycling run; 2:Auto stop after running for one cycle (STOP for intervention); 3: Auto Run and Cycling (STOP for intervention) | 0               |
|                            | CD078                        | PLC rotation Direction                  | 0~255 (0:For 1:Rev)   | 0               |
|                            | CD079                        | PLC Ramp Time                           | 0~65535   | 0               |
|                            | CD080                        | Frequency 2                             | 0.00-400.00 Hz  | 15.00           |
|                            | CD081                        | Frequency 3                             | 0.00-400.00 Hz  | 20.00           |
|                            | CD082                        | Frequency 4                             | 0.00-400.00 Hz  | 25.00           |
|                            | CD083                        | Frequency 5                             | 0.00-400.00 Hz  | 30.00           |
|                            | CD084                        | Frequency 6                             | 0.00-400.00 Hz  | 35.00           |
|                            | CD085                        | Frequency 7                             | 0.00-400.00 Hz  | 40.00           |
|                            | CD086                        | Frequency 8                             | 0.00-400.00 Hz  | 0.50            |
|                            | CD087                        | Timer 1                                 | 0.0-6500.0S   | 10.0            |
|                            | CD088                        | Timer 2                                 | 0.0-6500.0S   | 10.0            |
|                            | CD089                        | Timer 3                                 | 0.0-6500.0S   | 0.0             |
|                            | CD090                        | Timer 4                                 | 0.0-6500.0S   | 0.0             |
|                            | CD091                        | Timer 5                                 | 0.0-6500.0S   | 0.0             |
|                            | CD092                        | Timer 6                                 | 0.0-6500.0S   | 0.0             |
|                            | CD093                        | Timer 7                                 | 0.0-6500.0S   | 0.0             |
|                            | CD094                        | Timer 8                                 | 0.0-6500.0S   | 0.0             |
|                            | CD095                        | AutoPLC Memory                          | 0~1   | 0               |
|                            | CD096~<br>CD106              | Reserved                                |   |                 |
| CD107                      | Multi-output AO              | 0~7                                     | 0   |                 |
| CD108                      | Lower Analog output current  | 0~20mA                                  | 4   |                 |
| CD109                      | Higher Analog output current | 0~20mA                                  | 20  |                 |
| Multi-speed and Easy PLC   | CD110                        | Number of Auxiliary Pump                | 0~2   | 0               |
|                            | CD111                        | Continuous Operating Time of Aux. Pumps | 1~9000mim   | 60              |
|                            | CD112                        | Interlocking Time of Aux. Pumps         | 0.1~250.0s  | 5.0s            |
|                            | CD113                        | High Speed Running Time                 | 1~250s  | 60s             |
|                            | CD114                        | Low Speed Running Time                  | 1~250s  | 60s             |
|                            | CD115                        | Stopping Voltage Level                  | 1~150s  | 95%             |
|                            | CD116                        | Lasting Time of Stopping Voltage Level  | 1~250s  | 30s             |
|                            | CD117                        | Wakeup Level                            | 1~150s  | 80%             |
|                            | CD118                        | Sleep Frequency                         | 0.00~400.00   | 20.00           |
|                            | CD119                        | Lasting Time of Sleep Frequency         | 1~250s  | 20s             |

Parameter and Function List (Part 5)

| Category                           | Code                                     | Functions  | Set Range & Function Explanation | Factory Setting |
|------------------------------------|--|--|----------------------------------|-----------------|
| Parameters of Protection Functions | CD120                                    | Over-voltage Stall Prevention                      | 0:Invalid 1:Valid                | 1               |
|                                    | CD121                                    | Stall Prevention Level at Accel.                   | 0~200%                           | 150             |
|                                    | CD122                                    | Stall Prevention Level at Constant Speed           | 0~200%                           | 0               |
|                                    | CD123                                    | Stall Prevention Level at Decel.                   | 0~232%                           | 0               |
|                                    | CD124                                    | Over-torque Detect Mode                            | 0~3                              | 0               |
|                                    | CD125                                    | Over-torque Detect Level                           | 0~200%                           | 0               |
|                                    | CD126                                    | Over-torque Detect Time                            | 0.1~20.0S                        | 1.0             |
|                                    | CD127                                    | Decel. time for stall prevention at constant speed |                                  | 5.0             |
|                                    | CD128                                    | Fault restart time                                 |                                  | 1.0             |
| CD129                              | Voltage rise time during frequency track |  | 5                                |                 |
| Parameters of Motor Functions      | CD130                                    | Rated Motor Voltage                                | Set according to Motor nameplate | *               |
|                                    | CD131                                    | Rated Motor Current                                | Set according to Motor nameplate | *               |
|                                    | CD132                                    | Motor pole number.                                 | 02—10                            | 04              |
|                                    | CD133                                    | Rated Motor Revolution                             | 00—9999                          | 1440            |
|                                    | CD134                                    | Motor no-load current                              | 0—100                            | 40              |
|                                    | CD135                                    | Motor slip compensation                            | 0—1000                           | 0               |
|                                    | CD136                                    | Over-voltage set                                   | 00.00~99.99 Kg                   | 10.00           |
|                                    | CD137                                    | Over-voltage delay time                            | 0~250s                           | 5               |
|                                    | CD138                                    | Over-voltage Instauration Value                    | 0.00~9.99Kg                      | 1.00            |
|                                    | CD139                                    | Over-voltage Instauration time                     | 0~250s                           | 5               |
|                                    | CD140                                    | DC Braking level                                   | 0.0~20.0%                        | 2.0             |
|                                    | CD141                                    | DC Braking time at start                           | 0.0~25.0S                        | 0.0             |
|                                    | CD142                                    | DC Braking time at stop                            | 0.0~25.0S                        | 0.0             |
|                                    | CD143                                    | Frequency track time                               | 0.1~20.0S                        | 5.0             |
| CD144                              | Current level for frequency track        | 0~200%   | 150                              |                 |

**Parameter and Function List (Part 6)**

| Category                        | Code                  | Functions                        | Set Range & Function Explanation                             | Factory Setting            |   |
|---------------------------------|-----------------------|----------------------------------|--|----------------------------|---|
| Parameters of Special Functions | CD145                 | Restart after instantaneous Stop | 0:Invalid<br>1:Frequency track                               | 0                          |   |
|                                 | CD146                 | Allowable Power-Breakdown Time   | 0.1~5.0S   | 0.5                        |   |
|                                 | CD147                 | Number of Abnormal Restart       | 0—10   | 00                         |   |
|                                 | CD148                 | Auto Voltage Regulation          | 0:Invalid 1:Valid  | 1                          |   |
|                                 | CD149                 | Auto Energy Saving               | 0~10%  | 0                          |   |
|                                 | CD150                 | Proportional Constant (P)        | 0.0~1000.0%  | 100.0%                     |   |
|                                 | CD151                 | Integral Time (I)                | 0.1~*S   | 5.0                        |   |
|                                 | CD152                 | Differential Time (D)            | 0.01~10.00S  | 0                          |   |
|                                 | CD153                 | Target value                     | 0.0~100.0%   | 0                          |   |
|                                 | CD154                 | Target value select              | 0: set by the operator<br>1:set by external terminals(0-10V) | 0                          |   |
|                                 | CD155                 | PID upper limit                  | 0~100%   | 100%                       |   |
|                                 | CD156                 | PID lower limit                  | 0~100%   | 0%                         |   |
|                                 | CD157                 | PID Feedback select              | 0~3  | 0                          |   |
|                                 | CD158                 | Reserved                         |  |                            |   |
| Communication Functions         | CD159                 | Transducer measure               | 00.00~99.99Kg  | 10.00                      |   |
|                                 | CD160                 | Communication Addresses          | 0-250  | 0                          |   |
|                                 | CD161                 | CommunicationBaud Rate           | 0-3  |                            |   |
|                                 | CD162                 | Communication Data Method        | 0-5  | 10.00                      |   |
|                                 | CD163~<br>CD166       | Reserved                         |  |                            |   |
|                                 | Monitoring Parameters | CD167                            | Display Items  | 0-31                       | 0 |
|                                 |                       | CD168                            | Display Items Open   | 0-7                        | 0 |
|                                 |                       | CD169                            | Voltage Rating of Inverter                                   | Set according to the model | * |
|                                 |                       | CD170                            | Rated Current of Inverter                                    | Set according to the model | * |
|                                 |                       | CD171                            | Software Version   |                            | * |
| CD172                           |                       | Fault Record 1                   |  | ---                        |   |
| CD173                           |                       | Fault Record 2                   | Note: --- means no fault record.                             | ---                        |   |
| CD174                           |                       | Fault Record 3                   |  | ---                        |   |
| CD175                           | Fault Record 4        |                                  | ---  |                            |   |
| CD176                           | Fault Clear           | 00—10 (01 for Fault Clear)       | 00   |                            |   |

## Parameter and Function List (Part 7)

| Category        | Code            | Functions                   | Set Range & Function Explanation | Factory Setting |
|-----------------|-----------------|-----------------------------|----------------------------------|-----------------|
| Factory Setting | CD177           | Inverter Model              |                                  | 0               |
|                 | CD178           | Inverter Frequency Standard | 0:50Hz 1:60Hz                    | 0               |
|                 | CD179           | Manufacture Date            | Year:Month:Week                  | *               |
|                 | CD180           | Serial No.                  |                                  | *               |
|                 | CD181~<br>CD250 | Reserved                    |                                  |                 |

## IX. Descriptions of Functions

CD000 Main Frequency \*\*  
Set Range:0.00—400.00 Hz Unit:0.01 Hz Factory Setting:0.00

In the digital operator mode, the inverter will run at the set value of CD000. During running, the operating frequency can be changed by pressing ▲ or ▼. During multi-speed running, the main frequency is taken as the frequency of Speed 1.

In the external control multi-speed mode, if CD034 is set to 1, i.e. given by an external terminal, Speed 1 will be given by the analog of the external terminal.

The setting of main frequency is limited by the maximum operating frequency.

The related parameters of CD034, CD076 are adjustable during operation.

CD001 Max. Voltage  
Set Range:0.1—\* Unit:0.1V Factory Setting:220/380V

This parameter should be set according to the rated value of the motor's nameplate. The factory setting is 380V for 380V class motor and 220V for 220V class motor. The setting range of this parameter is restricted by the voltage rating of the inverter. In case of the motor relatively far away from the inverter this set value can be increased properly.

CD002 Base Frequency  
Set Range:0.01—400.00 Hz Unit:0.01Hz Factory Setting:50.00

This parameter must be set according to the rated frequency of operating voltage on the motor's nameplate. Under normal conditions do not change the set value of base frequency at will. If it is equipped with a special motor this value should be set properly according to the characteristics of the motor's parameters. Otherwise it may cause the damage to the equipment.

CD003 Intermediate voltage  
Set Range:0.1V—\* Unit:0.1V Factory Setting:\*

This parameter is set for an intermediate voltage value of arbitrary V/F

curve. If it is set improperly, it will cause over-current or under-torque of the motor, or even tripping of the inverter. When the intermediate frequency is increased the voltage will increase the output torque and at the same time also the output current. When changing this parameter please pay attention to monitoring the output current to avoid the inverter's tripping due to over-current.

This set value of intermediate voltage is limited by the set value of max voltage. When the voltage is increasing to a certain value at intermediate frequency the torque compensation will lose its function. When adjusting this parameter the output current of the inverter should be increased from low to high slowly according to the load of machines until it meets the starting requirement. Do not be quick to increase it by large amplitude. Otherwise it might cause the tripping of the inverter or the damage of the machines.

#### CD004 Intermediate Frequency

Set Range:0.01—400.00 Hz Unit:0.01 Hz Factory Setting:2.50

This parameter is set for intermediate frequency of arbitrary V/F curve. If it is set improperly, it will cause over-current or under-torque of the motor, or even tripping of the inverter.

This set value of intermediate frequency is limited by the set value of base frequency.

| code<br>Model | CD<br>003 | CD<br>005 | CD<br>012 | CD<br>013 | CD<br>035 | code<br>Model | CD<br>003 | CD<br>005 | CD<br>012 | CD<br>013 | CD<br>035 |
|---------------|-----------|-----------|-----------|-----------|-----------|---------------|-----------|-----------|-----------|-----------|-----------|
| P0D7523C      | 73        | 4         | 5         | 5         | 5         | P007543B      | 120       | 7.5       | 45        | 45        | 0         |
| P01D523C      | 73        | 4         | 8         | 8         | 5         | P009043B      | 120       | 7.5       | 50        | 50        | 0         |
| P02D223C      | 73        | 4         | 10        | 10        | 5         | P011043B      | 120       | 7         | 75        | 75        | 0         |
| P03D723B      | 73        | 4         | 10        | 10        | 5         | P013243B      | 120       | 7         | 100       | 100       | 0         |
| P05D523B      | 73        | 4         | 15        | 15        | 5         | P016043B      | 120       | 6.5       | 150       | 150       | 0         |
| P0D7543C      | 120       | 5         | 2         | 2         | 5         | P018543B      | 120       | 6.5       | 150       | 150       | 0         |
| P01D543C      | 120       | 5         | 8         | 8         | 5         | P020043B      | 120       | 6         | 200       | 200       | 0         |
| P02D243C      | 120       | 5         | 10        | 10        | 5         | P022043B      | 120       | 6         | 200       | 200       | 0         |
| P03D743C      | 120       | 5         | 15        | 15        | 5         | P025043B      | 120       | 5.5       | 250       | 250       | 0         |
| P05D543B      | 120       | 5         | 15        | 15        | 5         | P028043B      | 120       | 5.5       | 250       | 250       | 0         |
| P07D543B      | 120       | 5         | 15        | 15        | 5         | P030043B      | 120       | 5.5       | 250       | 250       | 0         |
| P001143B      | 120       | 5         | 20        | 20        | 5         | P031543B      | 120       | 5         | 250       | 250       | 0         |
| P001543B      | 120       | 9.5       | 20        | 20        | 0         | P034543B      | 120       | 5         | 250       | 250       | 0         |
| P18D543B      | 120       | 9.5       | 20        | 20        | 0         | P037543B      | 120       | 5         | 250       | 250       | 0         |
| P002243B      | 120       | 9         | 25        | 25        | 0         | P040043B      | 120       | 5         | 250       | 250       | 0         |
| P003043B      | 120       | 9         | 25        | 25        | 0         | P041543B      | 120       | 5         | 250       | 250       | 0         |
| P003743B      | 120       | 8.5       | 30        | 30        | 0         | P045043B      | 120       | 5         | 250       | 250       | 0         |
| P004543B      | 120       | 8         | 35        | 35        | 0         |               |           |           |           |           |           |
| P005543B      | 120       | 8         | 40        | 40        | 0         |               |           |           |           |           |           |

- Note: ① Ramp Time 2 = Ramp Time 1 x 2  
 ② Ramp Time 3 = Ramp Time 2 x 2  
 ③ Ramp Time 4 = Ramp Time 3 x 2  
 ④ Min.Voltage Value = Intermediate Voltage Value/2  
 ⑤ The intermediate frequency is 2.5 for the system of 50Hz.  
 ⑥ The intermediate frequency is 3.0 for the system of 60Hz.

**CD007 Max. Operating Frequency**

Set Range:10.00—400.00 Hz Unit:0.01 Hz Factory Setting:50.00

This parameter is set for the maximum operating frequency of the inverter.

The following are several curves and set values often used for reference. Specific curves must be set according to concrete characteristics of mechanical load.

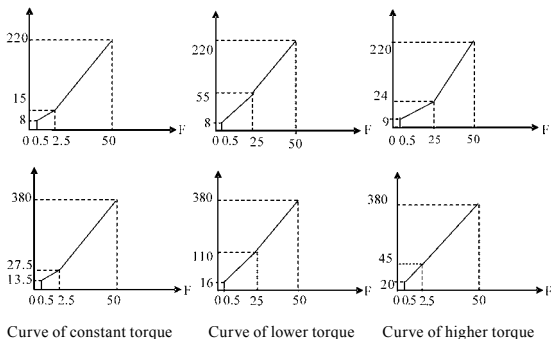
**CD008 Reserved**
**CD009 Frequency Lower Limit**

Set Range:0.00—400.00 Unit:0.01 Hz Factory Setting:0.00

\*\*

This is set for preventing workers from false operation to avoid over-heat or some other mechanical faults, which might be caused due to too low operating frequency.

The setting of Frequency Lower Limit must be less than the set value of CD007.



|       |                |                   |
|-------|----------------|-------------------|
| CD010 | Parameter Lock | **                |
|       | Set Range:0—1  | Unit:1            |
|       |                | Factory Setting:0 |

0: Invalid.

1: Valid, i.e. the parameters are locked. Except this parameter other parameters can not be changed.

This parameter is set to prevent non-maintenance personnel from setting other parameters by mistake. After the parameters are locked the operating frequency can be changed by pressing  $\Delta$  or  $\nabla$ .

|       |                 |                    |
|-------|-----------------|--------------------|
| CD011 | Parameter Reset | **                 |
|       | Set Range:00—10 | Unit:1             |
|       |                 | Factory Setting:00 |

When the value for a parameter is set improper or is abnormal for some reasons this parameter can be set to 08 to restore it to the factory setting and then reset. After the parameters are locked (in case of CD010=1) the parameters can't be reset. They can only be reset after unlock. For related parameters refer to CD010.

|       |                       |                    |
|-------|-----------------------|--------------------|
| CD012 | Accel. Time 1         | **                 |
|       | Set Range:0.1—6500.0S | Unit:0.1S          |
|       |                       | Factory Setting: * |
| CD013 | Decel. Time 1         | **                 |
|       | Set Range:0.1—6500.0S | Unit:0.1S          |
|       |                       | Factory Setting: * |
| CD014 | Accel. Time 2         | **                 |
|       | Set Range:0.1—6500.0S | Unit:0.1S          |
|       |                       | Factory Setting: * |
| CD015 | Decel. Time 2         | **                 |
|       | Set Range:0.1—6500.0S | Unit:0.1S          |
|       |                       | Factory Setting: * |
| CD016 | Accel. Time 3         | **                 |
|       | Set Range:0.1—6500.0S | Unit:0.1S          |
|       |                       | Factory Setting: * |
| CD017 | Decel. Time 3         | **                 |
|       | Set Range:0.1—6500.0S | Unit:0.1S          |
|       |                       | Factory Setting: * |
| CD018 | Accel. Time 4         | **                 |
|       | Set Range:0.1—6500.0S | Unit:0.1S          |
|       |                       | Factory Setting: * |
| CD019 | Decel. Time 4         | **                 |
|       | Set Range:0.1—6500.0S | Unit:0.1S          |
|       |                       | Factory Setting: * |

Ramp-up time means the time needed for the inverter to increase the frequency from 0Hz to the maximum operating frequency (See t1 in the diagram). Ramp-down Time means the time needed for the inverter to decrease the frequency from the maximum operating frequency to 0Hz (See t2 in the diagram).

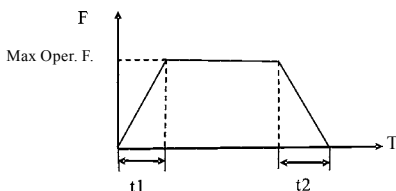

Note:

The versions previous to Vr2.0 took 50Hz as the base of ramp time. HLP-A Series inverter have altogether 4 Ramp Times. For Ramp Time 2.3.4 the user can select the different ramp up or down time through the external terminals or switching of ramp time according to the actual needs. In the internal control multi-speed operation, different ramp time can be selected through easy PLC.

Generally the default of the inverter is Ramp Time 1, which is factory set depending on the model. Ramp Time 4 is for the jogging ramp time. For the factory setting of parameters refer to the table in CD006.

The related parameters: CD050~CD055 and CD078.

CD020 Output Frequency at Over-voltage alarm

Set Range:0.00—\*      Unit:0.01      Factory Setting:5.00

CD021~CD030      Factory Reserved

CD031 Starting Mode

Set Range:0—1      Unit:1      Factory Setting:0

Two starting modes are available for the needs of different equipment.

0: Start from the starting frequency.

When CD141 is set to 0, i.e. DC braking is invalid at start, it starts running from the starting frequency. When CD141 is set to any non-zero value, i.e. DC braking is valid at start, it first performs a DC braking at start, and then starts from the starting frequency.

For the related parameters refer to CD040, CD140 and CD141.

1: Start by frequency track

This setting can be used for the restarting of large inertia load. When restarting, the inverter will trace the former frequency from the set frequency downward. In case of large inertia equipment, when restarting, it can implement the running command and track the former frequency right away without waiting for the complete stop of the equipment to save

time.

Note: When the inverter is restarted by frequency track, it will start tracking the frequency from its set frequency downward, and search it at the highest speed. When restarting, the current becomes higher, and over-current or stall may occur. So attention must be paid to the adjustment of current level of frequency track. Generally, CD144 is adjusted around 100. The concrete value can be set according to the characteristics of mechanical load.

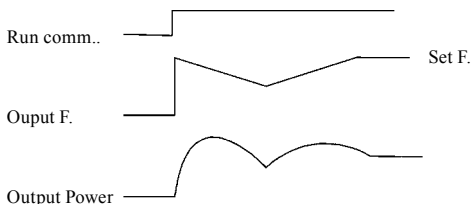

#### CD032 Stopping Mode

Set Range:0—1

Unit:1

Factory Setting:0

Two stopping modes are available for the needs of different equipment.

##### 0:Decelerating Stop

When CD142 is set to 0, DC braking is invalid. When DC braking is invalid, the inverter will decelerate to the stopping frequency, and then stop outputs, and the motor will coast to stop. When CD142 is set to any non-zero value, DC braking is valid, and the inverter will first decelerate to the stopping frequency, and then stop by DC braking.

DC braking at stop is usually used for high position stop or for positioning control. It must be noticed that frequent uses of DC braking will cause over-heat of the motor.

For the related parameters refer to CD042, CD140 and CD142.

##### 1:Coasting Stop

When the inverter receives a STOP command, it will immediately stop output and the motor will coast to stop. When the coasting stop mode is selected, DC braking is invalid.

#### CD033 Source of Operation Commands

Set Range:0—2

Unit:1

Factory Setting:0

0: Set by the Operator

Operation commands are given via the digital operator.

1: Set by external terminals.

Operation commands are given via external terminals, i.e. multi-input terminals

2: Set by communication ports.

Operation commands are given via communication ports.

**CD034 Source of Operating Frequency**

Set Range:0—2

Unit:1

Factory Setting:0

0: Set by the operator. Operating frequency is given via the digital operator.

1: Set by external terminals. Operating frequency is controlled by analog signals input via external terminals. The signal type is determined by CD065. For the related parameters refer to CD065-CD070.

2: Set by communication ports. Operating frequency is given via the serial communication.

**CD035 Carrier Frequency (Note: 0—15 corresponds to 0—20K Hz)**

Set Range:0—15

Unit:1

Factory Setting:\*

The carrier frequency has some relation with the electromagnetic noise of the motor, and meanwhile the level of the carrier frequency has certain relation with the heating capacity of the inverter and the interference to the environment. See the following table:

| Carrier Frequency | Electromagnetic Noise | Heating Capacity | Interference to the Environment |
|-------------------|-----------------------|------------------|---------------------------------|
| Low               | High                  | Small            | Little                          |
| ↓                 | ↓                     | ↓                | ↓                               |
| High              | Low                   | Large            | Great                           |

Carrier Frequency Corresponding Table

| Set Value             | 0   | 1 | 2   | 3 | 4 | 5 | 6 | 7 | 8 | 9 | 10 | 11 | 12 | 13 | 14 | 15 |
|-----------------------|-----|---|-----|---|---|---|---|---|---|---|----|----|----|----|----|----|
| Carrier Frequency KHz | 0.7 | 1 | 1.5 | 2 | 3 | 4 | 5 | 7 | 8 | 9 | 10 | 11 | 13 | 15 | 17 | 20 |

As shown in the table above, the higher the carrier is, the lower the electromagnetic noise of the motor will be, but the stronger its interference to other systems will be and the greater the heating capacity of the inverter will have. Under higher ambient temperature and heavier load of the motor the carrier frequency should be decreased properly to

improve the heat characteristics of the inverter.

The factory setting of carrier frequency is depending on the model. For specific data refer to the table in the description of CD006.

|                                 |                      |
|---------------------------------|----------------------|
| CD036 Jogging Frequency         | **                   |
| Set Range:0.00—400.00 Unit:0.01 | Factory Setting:5.00 |

The parameter set can realize the jogging function when the inverter is tested. The jogging operation can be only achieved through the external terminals, which can be set by multi-input terminals. Jogging frequency is limited by the frequency upper/lower limits. While the jogging function is implemented, other running commands are invalid. The ramp-up time of jogging frequency is set by Ramp-up Time 4. When the jog button is released the inverter will stop output immediately. In case of jogging function please set the corresponding multi-input terminals to 07 or 08.

This function is only valid at stop. It is invalid at running. For the related parameters refer to CD050-CD055.

|                           |                   |
|---------------------------|-------------------|
| CD037 Rev Rotation Select |                   |
| Set Range:0—1 Unit:1      | Factory Setting:1 |

0: Rev Rotation disable

1: Rev Rotation Enable

This function is suitable for the motor, which is not allowed to rotate reversely, to prevent workers from false operation. When the reverse rotation is disabled, the motor can only rotate forward, not reverse.

|                      |                   |
|----------------------|-------------------|
| CD038 STOP key       |                   |
| Set Range:0—1 Unit:1 | Factory Setting:1 |

0: STOP invalid.

1: STOP valid.

This parameter set is only valid when CD033 is set to 1 or 2.

When the control mode is set for external terminals or communication control, STOP key on the panel can be chosen to be valid or invalid. When choosing it as valid, STOP key can stop the inverter in running. When it needs to restart, the former running signal must be released before restarting the inverter.

**CD039 S-Curve Time**

Set Range:0.0—6500.0S Unit:0.1

Factory Setting:0.0

This parameter can be set for no impact slow start or slow stop of the inverter when starting or stopping. When starting S-curve the inverter will make accelerating or decelerating curve of different speed rates according to Ramp Time.

When CD039 is set as 0, S-curve is invalid, i.e. it will accelerate or decelerate in linear. Without consideration of stall the actual accel/decal time =  $(CD012+CD039)/2$ . The parameter is only valid when CD012 is less than CD039.

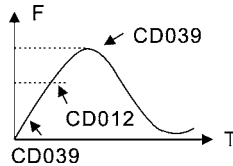
**CD040 Up/down Frequency Step Length: 0.01~2.50 Factory Setting: 0.01**

This parameter can be set in combination with CD073 for Up/Down of external control and the speed of increase and decrease. the step length of Up/Down= $(\text{the set value of CD040}/0.01) \times \text{UP/DOWN speed}$

**CD041 Starting Frequency**

Set Range:0.10—10.00 Hz Unit:0.01Hz

Factory Setting:0.50

Starting frequency is the initial frequency when the inverter is started. If the starting frequency is set to 4.0Hz, the inverter will run between 4.0Hz and the maximum operating frequency after its start at 4.0Hz. The actual maximum operating frequency is limited by the upper limit of frequency.

For the related parameters refer to CD031, CD140 and CD141.

**CD042 Stopping Frequency**

Set Range:0.10—10.00 Hz Unit:0.01Hz

Factory Setting:0.50

When stopping the inverter will decrease its frequency to the stopping frequency and then stop running or start DC braking to stop.

If CD142 is set to 0, DC braking is invalid at stop and the inverter will stop running.

If CD142 is set for valid, the inverter will stop by DC braking.

For the related parameters refer to CD032, CD140 and CD142.

**CD043 Auto Torque Compensation**

Set Range:0.0—10.0 % Unit:0.1%

Factory Setting:2.0%

This parameter can be set for the auto output of extra voltage when the inverter is running to achieve higher torque, which can compensate for the under-torque at lower frequency. The torque compensation should not be too big and it should be set slowly from low to high according to the actual situation.

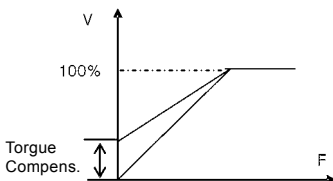

Insufficient compensation will result in the under-torque of the motor at lower frequency. And over compensation will lead to too bigger torque, which will produce a shock to the machine and even result in a trip of the inverter under serious situation.

**CD044 Skip Frequency 1**

\*\*

**CD045 Skip Frequency 2**
**CD046 Skip Frequency 3**

Set Range:0.00—400.00 Hz

Unit:0.01Hz

Factory Setting:0.0

**CD047 Skip Frequency Range**

\*\*

Set Range:0.10—10.00 Hz

Unit:0.01Hz

Factory Setting:0.50

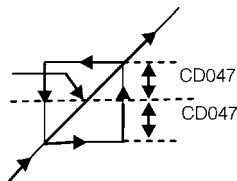
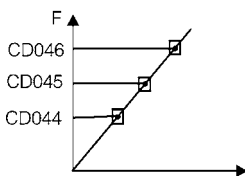

These three frequency skipping points are set for avoiding a mechanical resonance point. In case of CD047=0.1, all skip frequencies are invalid. The actual skip frequency range is two times that of CD047, as shown in the above diagram.

|       |              |                    |           |                     |
|-------|--------------|--------------------|-----------|---------------------|
| CD048 | Timer 1 Time | Set Range:0.1~10.0 | Unit: 0.1 | Factory Setting:0.1 |
| CD049 | Timer 2 Time | Set Range:1~100    | Unit: 1   | Factory Setting:1   |

Timer 1 is a timer of 0.1s ~ 10.0s and Timer 2 is a timer of 1s ~ 100s. When the timer start at multi-inputs is closed (on) the timer starts to count time. When it reaches the set time the corresponding multi-output contact will act. When the timer start is opened (off) the timer time at the multi-output will be reset.

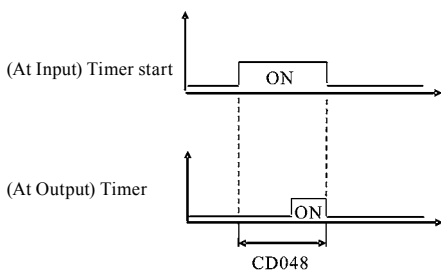

For example, set CD048=5.0s. When the external control terminal (Multi-Input) is valid the output terminal will be valid after five (5.0) seconds, the signal of which can be used to control other corresponding signals.

|       |                             |                     |
|-------|-----------------------------|---------------------|
| CD050 | Multi-input 1(FOR function) | Factory Setting: 02 |
| CD051 | Multi-input 2(REV function) | Factory Setting: 03 |
| CD052 | Multi-input 3(RST function) | Factory Setting: 10 |
| CD053 | Multi-input 4(SPH function) | Factory Setting: 17 |
| CD054 | Multi-input 5(SPM function) | Factory Setting: 18 |
| CD055 | Multi-input 6(SPL function) | Factory Setting: 19 |
|       | Set Range:00—32             | Unit:No             |

|              |   |
|--------------|---|
| 00: Invalid. | The terminal is set for empty to prevent false actions.                             |
| 01: RUN      | Running. It can be combined with other terminals to compose multiple control modes. |
| 02: FOR      | Forward Rotation  |
| 03: REV      | Reverse Rotation  |
| 04: STOP     | Stopping  |
| 05: FOR/REV  | Switching of FOR/REV rotation   |
| 06: JOG      | Jogging   |



- 07: Jog FOR Rotation
- 08: Jog REV Rotation
- 09: Emergent Stop: Emergent stop. It can receive external emergent stop command or other fault signals
- 10: RST Reset. This terminal can be used for reset after a fault is removed.
- 11: Reserved
- 12: Over-heat of heat sink or motor: This contact can be used to detect over-heat of the heat sink or motor to protect the motor and inverter.
- 13: External Control Timer 1 Start: When the contact is closed, the timer will start and begin to count time. When the timer reaches the set point the corresponding multi-inputs will act.
- 14: External Control Timer 2 Start
- 15~16: Reserved
- 17: High speed High, middle and low speed can compose three kinds of operation mode
- 18: Middle speed with different frequencies. In the three terminals the high-end signal has
- 19: Low speed priority. Low, Middle and High Speed are determined respectively by Frequency 2, 3, 4.
- 20: Multi-speed 1 7-speed setting can be composed through Multi-speed 1, 2, 3.
- 21: Multi-speed 2
- 22: Multi-speed 3
- 23: Ramp Time 1: This terminal can be used to select the ramp time of the inverter.
- 24: Ramp Time 2: 4 kinds of ramp time are available for choice.
- 25: UP Function When the switch of this terminal acts the frequency setting of the inverter will be increased or decreased by one unit. When the switch of the terminal is hold the frequency will increase or decrease rapidly to a point and then increase or decrease
- 26: Down Function at even speed. When the power is up again after the power breakdown the changed frequency will not be memorized.
- 27: Counter Pulse When this terminal is set for the counter it can receive the pulse signal of  $\leq 250\text{HZ}$  and counts.
- 28: Counter Reset When this contact acts it will clear the present counting values displayed, restore C00 and restart counting.
- 29: Drawing Start When this contact is triggered the drawing action starts.

31:AutoPLC Reset Suspend This contact can be used to achieve the function of AutoPLC clear suspend.

32: PID Valid When this contact is closed, PID function starts. PID Function start is only valid during operation.

Explanation:

1. Three multi-function terminals can be used for the connection method of three-wire system for the realization of switching of FOR/REV rotation, which is extensively applied in the cases of FOR/REV switching of photoelectric switches.

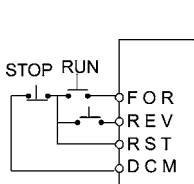

① Select FOR, REV and RST.

② Parameter setting:

CD033=1 for external control

CD050=02 for FOR rotation

CD051=03 for REV Rotation

CD052=04 for Stop

③ Action Description:

When triggering FOR, the inverter will rotate forward (start);

When triggering REV, the inverter will rotate reverse;

When pressing STOP, the inverter will stop.

2. RUN, DCM, F/R can be used for Start, Stop and switching of FOR/REV:

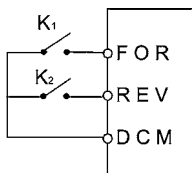

① Select FOR and REV

② Parameter setting:

CD033=1 for external control

CD050=01 for RUN function

CD051=05 for switching of F/R

When K2 is opened it rotates forward, while K2 is closed it rotates reverse.

3. Description of Ramp Time 1 and 2:

1)This function is only valid when CD076 is set to 0, 1 and 2. Under the disturbance and internal control multi-speed it is invalid.

2)Any two multi-inputs can be combined for 4 kinds of ramp time for selection.

3)The related multi-inputs are set for Ramp Time 1, 2. Take the terminals of SPH and SPM as example, when SPH CD053 is set to 23 and SPM CD054 is set to 24, SPH and SPM are now Ramp Time 1, 2.

| SPH | SPM | Result      |
|-----|-----|-------------|
| OFF | OFF | Ramp Time 1 |
| ON  | OFF | Ramp Time 2 |
| OFF | ON  | Ramp Time 3 |
| ON  | ON  | Ramp Time 4 |

4. Function description of High, Middle and low speed terminals:

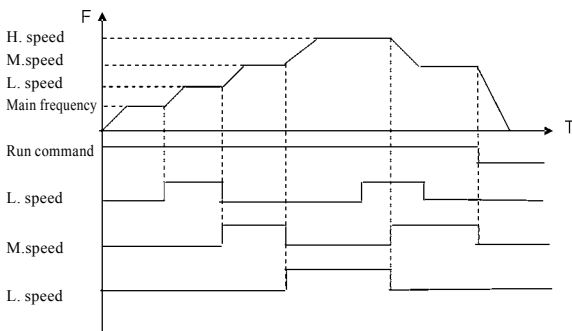

| RUN | SPL    | SPM    | SPH | Result  |
|-----|--------|--------|-----|---|
| ON  | OFF    | OFF    | OFF | Main speed, the frequency runs at the set value of CD000.   |
| ON  | ON     | OFF    | OFF | Low speed, the frequency runs at the set value of CD080.    |
| ON  | ON/OFF | ON     | OFF | Middle speed, the frequency runs at the set value of CD081. |
| ON  | ON/OFF | ON/OFF | ON  | High speed, the frequency runs at the set value of CD082.   |

Note:

- (1) This function is only valid when CD076 is set to 1, i.e. for 4-Speed of external control.
- (2) Low, middle and high speed frequency are determined by Frequency 2,3, 4.
- (3) Ramp time is determined by Ramp Select terminal.
- (4) When all high, middle and low speeds have signal inputs it will give priority in the sequence of high, middle and low speed.

## 5. Description of UP and DOWN Function:

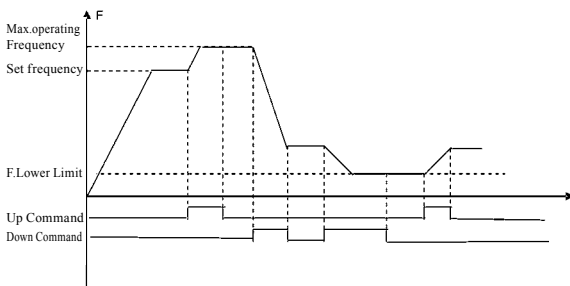

| UP  | DOWN | Result                   |
|-----|------|--------------------------|
| ON  | OFF  | Frequency increase       |
| OFF | ON   | Frequency decrease       |
| ON  | ON   | Not increase or decrease |

## Note:

- (1)The function of UP and DOWN is only valid when the operator is selected for the source of the operating frequency, i.e. CD034=0.
- (2)When the UP terminal is closed the frequency of the inverter will increase.
- (3)When the DOWN terminal is closed the frequency of the inverter will decrease.
- (4)When both UP and DOWN terminals are closed at the same time the frequency will neither increase nor decrease. It is regarded as invalid.
- (5)When the frequency reaches the max operating frequency it will stop increasing.
- (6)When the frequency reaches the min frequency or its lower limit, it will stop decreasing.
- (7)After a power breakdown the set value of CD000 will be memorized instead of the frequency.
- (8)When using the function of UP and DOWN, the keys of  $\triangle$   $\nabla$  of the panel are valid. After changing the values it needs to press SET (ENTER) key for confirmation and then the inverter can implement the action. Meanwhile the value will write to CD000, which will be memorized after a power breakdown.
- (9)When keeping pressing UP or DOWN, the frequency will increase or decrease rapidly to a point and then increase or decrease at even speed.
- (10)The value changed by UP or DOWN can be set through CD072 for

confirmation of whether it should be memorized or not memorized. For details refer to CD072.

#### 6. Function Description of Multi-speed 1, 2 and 3:

They are only valid when CD076 is set to 2. For details refer to CD076.

#### 7. Function Description of Counter:

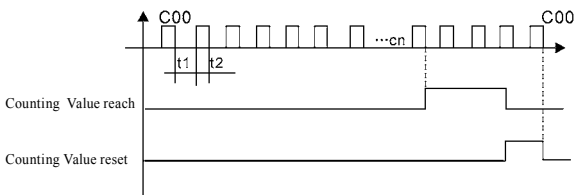

Note:

- (1) The signal width triggered should not be lower than 2 msec ( $t_1, t_2 \geq 2\text{msec}$ ).
- (2) When the counting value is reached the corresponding multi-output contact will act.
- (3) This counter can only count again after reset.
- (4) When reaching to 65535 the counter will not count again.

#### 8. Description of AutoPLC Clear Suspend:

For details refer to 10. Example Application of AutoPLC Suspend in Appendix 1 and the description of related parameters in CD095.

|        |                                     |                      |
|--------|-------------------------------------|----------------------|
| *CD056 | Multi-Output 1(DRV function)        | Factory Setting:01** |
| *CD057 | Multi-Output 2(UPF function)        | Factory Setting:05   |
| *CD058 | Multi-Output 3(FA, FB, FC function) | Factory Setting:02   |
| *CD059 | Multi-Output 4(KA, KB function)     | Factory Setting:00   |
|        | Set Range:00—32                     | Unit:1               |

00: Invalid: The terminal is set for no function to prevent false actions.

01: In Run: The contact will act when the inverter has output or receives the running command.

02: Fault Indication: The contact will act when the inverter detects abnormal conditions.

03: Zero Speed: The contact will act when the output frequency of the inverter is less than its starting frequency.

04: DC Braking indication: The contact will act when the inverter is in DC braking.

- 05: Set Frequency reach: The contact will act when the output frequency of the inverter reaches the set frequency.
- 06: Uniform Frequency 1 Reach: The contact will act when the output frequency of the inverter reaches the designated frequency (CD061).
- 07: Uniform Frequency 2 reach: The contact will act when the output frequency of the inverter reaches the designated frequency (CD062).
- 08: In Accel: The contact will act when the inverter is in ramp-up.
- 09: In Decel: The contact will act when the inverter is in ramp-down.
- 10: Inverter Over-load Alarm: The contact will act when the inverter detects over-load.
- 11: Motor Overload Alarm: The contact will act when the inverter detects over-load of the motor.
- 12: In Over-torque Detect: The contact will act when the inverter detects over-torque.
- 13: Low Voltage Alarm: The contact will act when the inverter detects low voltage.
- 14: Single Step End: The contact will act and generate one pulse when the inverter finishes a single step in implementation of program operation.
- 15: Process End: The contact will act and generate one pulse when the inverter finishes all the steps (i.e. after one cycle) in implementation of program operation.
- 16: Set Counter Reach: The contact will act when the inverter implements the external counter and the counting value is equal to the set value (CD064).
- 17: Middle Counter Reach: The contact will act when the inverter implements the external counter and the counting value is greater than or equal to the set value (CD075).
- 18: External Control Timer 1 reach: The contact will act when the timer reaches the set value.
- 19: External Control Timer 2 reach:
- 20: 4~20mA disconnected: When AI input signal is opened the contact will act.
- 25: Auxiliary Pump 1: This contact controls the starting and stopping of auxiliary pumps. For details refer to Operation of Multi-pumps.
- 26: Auxiliary Pump 2
- 27: Drawing reach: The contact will act when the drawing action is finished. The contact will automatically reset when the inverter stops.
- 28: PID Lower Limit Alarm: This contact will act when the PID feedback is smaller than the lower limit (the set value of CD156).
- 29: PID Upper Limit Alarm: This contact will act when the PID feedback

is greater than the upper limit (the set value of CD155).

- 30:Fan act: When the temperature of the inverter is increased or it is in running, this contact will act.
- 31:Electromagnetic Relay Act: When the contact pulls in, the corresponding multi-function terminal will act.
- 32:Braking Resistor Act: When the inverter is in running and the DC voltage reaches the braking voltage the contact will act.

|                          |                   |
|--------------------------|-------------------|
| CD060 Multi-Output AM/VO | **                |
| Set Range:0—7            | Unit:1            |
|                          | Factory Setting:0 |

Functions: Output terminal of digital frequency, generating pulse or 0—10V analog. In combination with CD071 it can be connected with a corresponding instrument with the measuring range below 10 to be used for external monitoring.

0:0~10V analog output, corresponding to output frequency. 0~10V corresponds to 0~Maximum operating frequency

1:0~10V analog output, corresponding to output current. 0~10V corresponds to 0~two times of the rated current of the inverter.

2:Analog output, corresponding to DC bus voltage. 0~10V corresponds to 0~1000V.

3:Analog output, corresponding to AC output voltage. 0~10V corresponds to 0~510V/255V.

(Note: The machine type of three phase, 380V corresponds to 510V and the machine type of single phase, 220V corresponds to 255V)

4:Pulse Output, corresponding to operating frequency: 1 Pulse/Hz,(50% of capacity ratio)

5:Pulse Output, corresponding to operating frequency: 2 Pulse /Hz,(50% of capacity ratio)

6:Pulse Output, corresponding to operating frequency: 3 Pulse /Hz,(50% of capacity ratio)

7:Pulse Output, corresponding to operating frequency: 6 Pulse /Hz,(50% of capacity ratio)

|                               |                      |
|-------------------------------|----------------------|
| CD061 Uniform Frequency 1     | **                   |
| CD062 Uniform Frequency 2     |                      |
| Set Range:0.00—400.00 Hz      | Unit:0.01 Hz         |
|                               | Factory Setting:0.00 |
| CD063 Uniform Frequency Range | **                   |
| Set Range:0.10—10.00 Hz       | Unit:0.01 Hz         |
|                               | Factory Setting:0.50 |

When the output frequency is more than the uniform frequency the corresponding multi-outputs will act. The uniform frequency range acts

as a hysteresis loop.

When the inverter is in the operation of multi-pumps, CD061 (Uniform Frequency 1) is used as high speed frequency and CD062 is set as low speed operating frequency. The definitions of the corresponding multi-function contacts are changed.

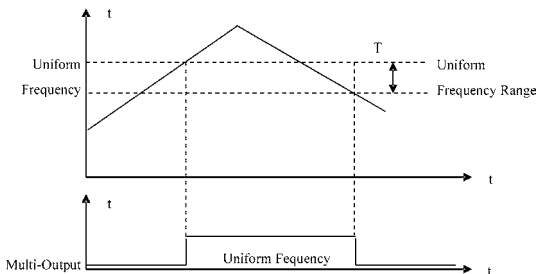

When output F. is higher than uniform F, the corresp. multioutputs act. The uniform F. range is used as hysteresis LOOP.

CD064 Counting Value \*\*  
 Set Range:0—65500 Unit:1 Factory Setting:0

An external terminal of multi-function can be used as a trigger for the counter. When the counter reaches the set value of CD064 the corresponding multi-output contact will act. After the counter is cleared and reset it will start counting again. A proximity switch or optoelectronic switch can be used for the triggering signals.

CD065 Analog Input  
 Set Range:0—7 Unit:1 Factory Setting:0

0:0~10V (VI)      1:0~5V (VI)      2:0~20mA (AI)  
 3:4~20M(AI)      4:0-10V (VI)and 4-20mA stacked (AI)  
 5:0~10V (RI)      6:0-10V (RI)and 0-10V stacked (VI)  
 7:0-10V (RI)and 0-20mA stacked (AI)

This parameter can be set for different analog input signals.

When CD065=4, the output frequency =  $1/2(U/U_{max} + I/I_{max}) \times 50\text{Hz}$

Among which: U: Analog Voltage;  $U_{max}$ : Maximum Analog Voltage;

I: Analog Current;  $I_{max}$ : Maximum Analog Current.

For example, When +10V and 20mA are respectively entered for the analog input, the output frequency of the inverter is 50Hz.



## CD066 Lower Analog Frequency

Set Range:0.00—400.00 Hz Unit:0.01 Hz Factory Setting:0.00

## CD067 Bias Direction at Lower Frequency

Set Range:0—1 Unit:1 Factory Setting:0

0:Positive direction

1:Negative direction

Bias direction means the instruction of FOR/REV rotation command. Positive bias indicates forward rotation while negative bias indicates reverse rotation. For details refer to the diagram in CD070.

## CD068 Higher Analog Frequency

Set Range:0.00—600.00 Hz Unit:0.01Hz Factory Setting:50.00

## CD069 Bias Direction at Higher Frequency

Set Range:0—1 Unit:1 Factory Setting:0

0:Positive direction

1:Negative direction

Bias direction means the instruction of FOR/REV rotation command. Positive bias indicates forward rotation while negative bias indicates reverse rotation. For details refer to the diagram in CD070.

## CD070 Analog Negative Bias Reverse

Set Range:0—1 Unit:1 Factory Setting:0

0:Negative bias Rev is not allowable.

1:Negative bias Rev is allowable.

The parameter group is set for the measuring range and zero point of the external analog terminals and can be combined for any kind of curve to control the operation of the motor.

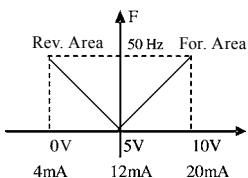

Setting:CD066=50

CD067=1

CD068=50

CD069=0

CD070=1

Note: this curve can be easily used in complicated applications in combination with other curves. When using it the instruction of FOR/REV run from external terminals is still valid. When switching, the curve will turn reverse.

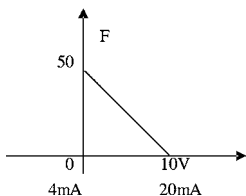

Setting: CD066=50 CD067=0  
 CD068=0 CD069=0  
 CD070=0

Note: this curve is a kind of special application of reverse ramp setting. When using transmitter for the control of pressure, temperature and others and while the control has higher pressure and output signals but requiring the corresponding commands of stop or deceleration on the inverter this curve can satisfy the demand properly.

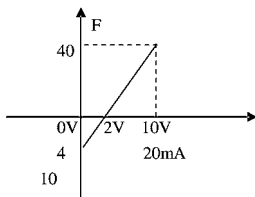

Setting: CD066=10 CD067=1  
 CD068=40 CD069=0  
 CD070=1

Note: this method is used extensively. The user can use it flexibly.

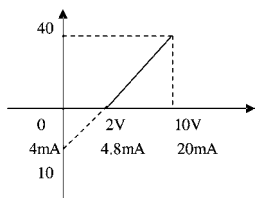

Setting: CD066=10 CD067=1  
 CD068=40 CD069=0  
 CD070=1

Note: this curve is the extension of the above curve. 2V~10V(4.8mA~20mA) corresponds to 0Hz~40HZ; the signal of 0V~2V(4~4.8mA) is invalid. It can be used to avoid noise disturbance. In harsh environment it is better not to use signals below 1V for setting the operating frequency of the inverter.

#### CD071 AM /VO Analog Output Gain

Set Range:0.0—100.0% Unit:0.1% Factory Setting:100.0

This parameter can be used to adjust the output voltage value of Multi-output 6 to adapt to frequency meters with different measuring range and also used to correct a frequency meter. For example, for an externally connected frequency meter with the measuring range of 0~5V, a multi-function terminal can be used to display its operating frequency. Then it can be corrected with this parameter. It can be achieved by setting CD071=50 .

**CD072 UP/DOWN Function**

Set Range:0-1

Unit:1

Factory Setting:0

0: Not memorized

1:Memorized

This parameter can be set for the selection of whether the values changed by the UP or DOWN shall be memorized or not after stop. The changed values whether to be memorized or not means when they are changed by UP or DOWN during operation and the inverter is restarted after stop these changed values shall be memorized or not after restart. When CD072 is set to 0, the changed value will not be memorized and when it is set to 1, the changed values will be memorized. The set values of CD000 will be memorized after restart.

For the related parameters refer to CD050-CD055.

**CD073 UP/DOWN Speed**

Set Range:0-1

Unit:1

Factory Setting:0

0: 0.1Hz. Minimum UP/DOWN speed is 0.1Hz.

1: 0.01Hz. Minimum UP/DOWN speed is 0.01Hz.

Through the changes of this set value the UP/DOWN speed unit can be adjusted to meet the needs of different customers.

**CD074 Analog Filtering Constant**

Set Range:0-50

Unit:1

Factory Setting:20

The setting of this parameter is related to the analog responding speed. The higher the value of CD074 is set, the lower the analog responding speed will be.

**CD075 Intermediate Counter**

Set Range:0-65500

Unit:1

Factory Setting:0

Refer to CD064.

**CD076 PLC Operation**

Set Range:0—5

Unit:1

Factory Setting:0

0:Normal operation, i.e. the inverter is running in the normal control mode.

1:External control 4-Speeds (Refer to the function description and diagram of three terminals of high, middle and low speed in C050~C055)

2:External control multi-speeds

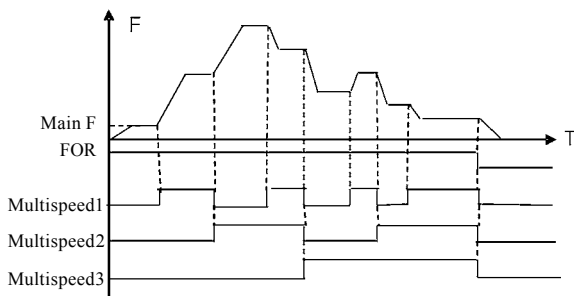

| Multi-function Terminals |               |               | Results  |
|--------------------------|---------------|---------------|--|
| Multi-speed 1            | Multi-speed 2 | Multi-speed 3 |  |
| OFF                      | OFF           | OFF           | Main frequency and frequencies are determined by CD000 or potentiometer. |
| ON                       | OFF           | OFF           | Multi-speed 1 and frequency are determined by CD080.                     |
| OFF                      | ON            | OFF           | Multi-speed 2 and frequency are determined by CD081.                     |
| ON                       | ON            | OFF           | Multi-speed 3 and frequency are determined by CD082.                     |
| OFF                      | OFF           | ON            | Multi-speed 4 and frequency are determined by CD083.                     |
| ON                       | OFF           | ON            | Multi-speed 5 and frequency are determined by CD084.                     |
| OFF                      | ON            | ON            | Multi-speed 6 and frequency are determined by CD085.                     |
| ON                       | ON            | ON            | Multi-speed 7 and frequency are determined by CD086.                     |

Note:

- ① It is only valid to realize the external control 8-Speeds operation when Multi-inputs are set for Multi-speed 1, 2, 3 and CD076 is set to 2.
- ② Multi-speed 1, 2, 3 can be used to make up 7-Speeds and 8-Speeds adding the main frequency.
- ③ The frequencies of Speed Step 1 ~ Step 7 are determined by CD080~CD086.
- ④ Each ramp time is determined by the external multi-function terminal.

- ⑤ The directions of each program operation are determined by the external multi-function terminals.
- ⑥ The main frequency can be set in two ways. One method is to set it through CD000 and another is to set it through the potentiometer. When CD034 is set to 1 the frequency of Main Frequency is set by the potentiometer. For the related parameters refer to CD000, CD034 and CD080~CD086.

### 3:Disturbance (Traverse function)

This is a special parameter in the chemical fiber and printing and dyeing industries to realize the traverse function. Except the commands of stop, external faults and emergency stop all other commands are not accepted at running.

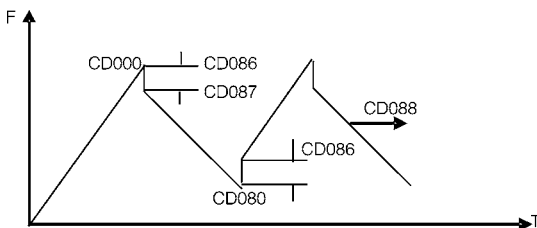

Note:

- ① The frequency at each inflection point is determined by CD000 and CD080.
- ② Skip Frequency is determined by CD086.
- ③ Running Time is determined by Timer CD087 and CD088.
- ④ The related parameters: CD000, CD080~CD088.

### 4:Internal control Multi-speeds

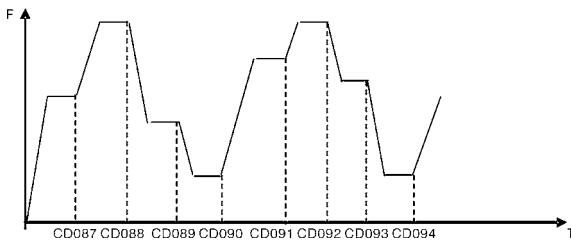

Note:

- ① Main speed and 7-speeds composes 8-speeds.
- ② The ramp time of each speed step is set by PLC Ramp Time CD079. Refer to the detail descriptions of CD079.
- ③ Running Time is set by Timer CD087~CD094. For the control steps not to be used the timer can be set to 0.
- ④ Running direction of each speed step is determined by CD078.
- ⑤ In the internal control multi-speed operation the running time and direction are determined by the setting of internal parameters. Any switching of external time and FOR/REV rotation is invalid.

### 5:Drawing

This is a special parameter for the constant speed of unwinding and rewinding. By using this function the linear speed constant in certain accuracy can be realized.

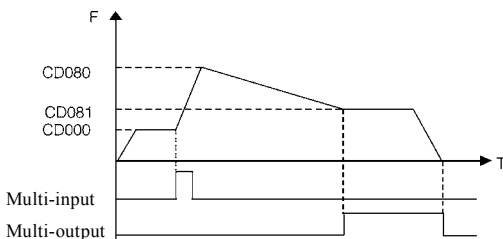

Note:

- ① Through triggering of the external multi-function terminal the drawing action begins.
- ② In implementation of the drawing action the actual running time is  $T = CD087 \times 10$ .
- ③ when the drawing action is finished the inverter will run at the constant speed of CD081 and the corresponding multi-output contact will act at the same time. Until receiving the STOP command the inverter will stop running and the multi-output contact will reset.

CD077 Auto PLC

Set Range:0—3

Unit:1

Factory Setting:0

0:Stop after the program runs one cycle.

1:Cycling running.

2:Stop after it runs one cycle automatically(STOP for intervention).

### 3:Auto running and cycling (STOP for intervention)

This parameter setting is only valid when CD076 is set to 4. For relevant parameters refer to CD000, CD076 and CD078~CD094.

Explanation:

1.Stop after the program runs one cycle.

When the command of auto program operation is given, the inverter will run with each set value of internal parameters. It will run for one cycle and then stop automatically. The inverter will not restart and run until it receives another command of operation.

2.Cycling run.

When the command of operation is given, the inverter will run in sequence with the frequency of every speed step and running time set by each of the internal parameters and will recycle. During the cycling run, except the commands of stop, external faults and emergency stop, all other commands will not be accepted.

3.Stop after it runs one cycle automatically(STOP for intervention)

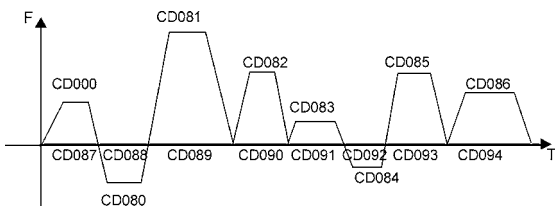

Note:

- ① When the command of auto program operation is given the inverter will run with each parameters. But it will stop first and then restart at changing of each step and will stop automatically after running for one cycle. The inverter will not restart and run until it receives another command of operation.
- ② The frequencies of each speed step are set by CD000 and CD080~CD086.
- ③ The running times of each speed step are set by CD087~CD094.
- ④ The running direction is set by CD078.

CD078 PLC Running Direction

Set Range:0—255

Unit:1

Factory Setting:0

This parameter is only valid when CD076 is set to 4. This parameter setting determine the running direction of each frequency of CD080~CD086 and CD000 in the program operation. The setting

method is as follows:

The rotation direction is set first in the binary 8 bits mode, and then converted to a decimal value for the setting of this parameter. For instance:

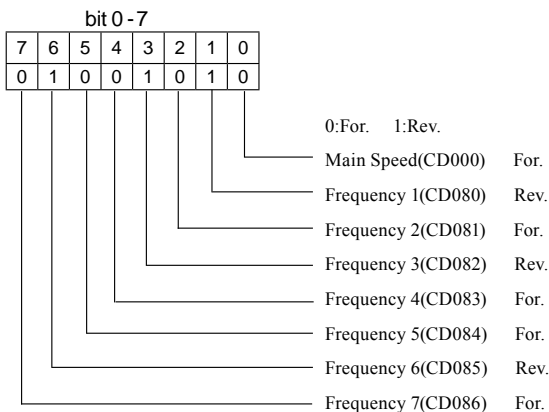

The parameter value 01001010 is converted to a decimal value:

$$1 \times 2^6 + 1 \times 2^3 + 1 \times 2^1 = 64 + 8 + 2 = 74$$

Then CD078=74

CD079 PLC Ramp Time

Set Range:0~65535

Unit:1S

Factory Setting:0

This parameter is only valid when CD076 is set to 4.

This parameter is set to determine the ramp time values for Step 1~4 of the internal control multi-speed. The setting method is as follows:

① Determine each Ramp Time in the binary 2 bit mode

| Bit1 | Bit0 | Ramp Time                |
|------|------|--------------------------|
| 0    | 0    | Ramp Time 1 CD012, CD013 |
| 0    | 1    | Ramp Time 2 CD014, CD015 |
| 1    | 0    | Ramp Time 3 CD016, CD017 |
| 1    | 1    | Ramp Time 4 CD018, CD019 |



② Determine the Ramp time of each speed step in the binary 16 bit mode

| Step 8 |   | Step 7 |   | Step 6 |   | Step 5 |   | Step 4 |   | Step 3 |   | Step 2 |   | Step 1 |   |
|--------|---|--------|---|--------|---|--------|---|--------|---|--------|---|--------|---|--------|---|
| t8     |   | t7     |   | t6     |   | t5     |   | t4     |   | t3     |   | t2     |   | t1     |   |
| 0      | 0 | 0      | 0 | 0      | 0 | 0      | 0 | 0      | 1 | 1      | 0 | 0      | 0 | 1      | 1 |

t1 Select Ramp Time 4

t2 Select Ramp Time 1

t3 Select Ramp Time 3

t4 Select Ramp Time 2

t5 Select Ramp Time 1

t6 Select Ramp Time 1

t7 Select Ramp Time 1

t8 Select Ramp Time 1

The setting value:

$$1 \times 2^0 + 1 \times 2^1 + 1 \times 2^5 + 1 \times 2^6 = 99$$

So CD079 is set to 99

$$\text{Attach: } 2^0=1 \quad 2^1=2 \quad 2^2=4 \quad 2^3=8$$

$$2^4=16 \quad 2^5=32 \quad 2^6=64 \quad 2^7=128$$

|                          |             |                 |         |
|--------------------------|-------------|-----------------|---------|
| CD080                    | Frequency 2 | Factory Setting | 15.00** |
| CD081                    | Frequency 3 | Factory Setting | 20.00   |
| CD082                    | Frequency 4 | Factory Setting | 25.00   |
| CD083                    | Frequency 5 | Factory Setting | 30.00   |
| CD084                    | Frequency 6 | Factory Setting | 35.00   |
| CD085                    | Frequency 7 | Factory Setting | 40.00   |
| CD086                    | Frequency 8 | Factory Setting | 0.50    |
| Set Range:0.00—400.00 Hz |             | Unit:0.01 Hz    |         |

This parameter is set in combination of the multi-inputs to select 4-speeds of external control, multi-speeds of external control or multi-speeds of internal control. For the relevant parameters refer to the description of CD076 and CD087~CD094.

|                       |         |                 |        |
|-----------------------|---------|-----------------|--------|
| CD087                 | Timer 1 | Factory Setting | 10.0** |
| CD088                 | Timer 2 | Factory Setting | 10.0   |
| CD089                 | Timer 3 | Factory Setting | 0.0    |
| CD090                 | Timer 4 | Factory Setting | 0.0    |
| CD091                 | Timer 5 | Factory Setting | 0.0    |
| CD092                 | Timer 6 | Factory Setting | 0.0    |
| CD093                 | Timer 7 | Factory Setting | 0.0    |
| CD094                 | Timer 8 | Factory Setting | 0.0    |
| Set Range:0.0—6500.0S |         | Unit:0.1S       |        |

This parameter is set for the internal control multi-speeds and the running time of drawing function. For the relevant parameter refer to CD076 and CD080~CD088.

**CD095 AutoPLC Memory Function**

Set Range:0—1

Factory Setting:0

0:Not memorized

1:Memorized

This parameter is set to determine whether the inverter is to realize the suspending function in AutoPLC mode. In case of CD095=1 it can memorize the status in which the inverter is running and will memorize it at stop or fail. It will continue to run when returning to normal. In case of CD095=0 it will not memorize. For specific applications refer to Example Application 10 in Appendix 1.

**CD096~D109 Reserved**
**\*CD110 Number of Auxiliary Pump**

Set Range:0—2

Unit:1

Factory Setting:0

This parameter is set for the number of auxiliary pump. The start or stop of the auxiliary pumps is controlled by using the multi-output contacts and Auxiliary Pump 1 or Auxiliary Pump 2 is controlled through the peripheral control circuit.

**\*CD111 Continuous Running Time of Auxiliary Pumps**

Set Range:1—9000(min) Unit:1

Factory Setting:60

In case of two pumps with only one pump in duty, in order to ensure each pump to work evenly, it will be switched to another pump when its running time reaches the set value of CD111.

**\*CD112 Interlocking Time of Auxiliary Pump**

Set Range:0.1—250.0S Unit:0.1

Factory Setting:3.0S

This parameter is set to determine the interlocking time of two auxiliary pumps when switching with each other.

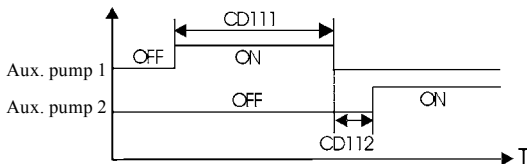

**\*CD113 High Speed Running Time**

Set Range:1—250S

Unit:1

Factory Setting:60S

In the application of water supply with constant pressure, when the master pump is running at the frequency of high speed (set by CD061) due to larger water volume and the high speed running time (CD113) is reached, the corresponding multi-function contacts act and the auxiliary pumps start.

**\*CD114 Low Speed Running Time**

Set Range:1—250S

Unit:1

Factory Setting:60S

In the application of water supply with constant pressure, when the master pump is running at the frequency of low speed (set by CD062) due to smaller water volume and the low speed running time (CD114) is reached, the corresponding multi-function contacts act and the auxiliary pumps stop.

CD113 and CD114 must be used in combination of CD061, CD062 and multi-outputs. Their main function is to increase or decrease the number of auxiliary pump.

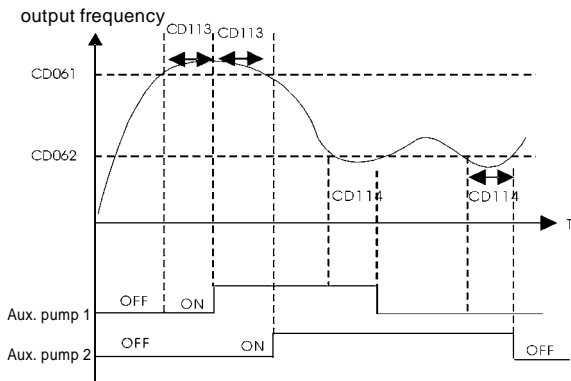

**\*CD115 Stopping Voltage Level**

Set Range:0—150%

Unit:1

Factory Setting:95%

This parameter is set for the voltage level of the master pump entering

into sleep mode. For details refer to the following description.

Stopping Voltage=PID Target Value×CD115

\*CD116 Lasting Time of Stopping Voltage Level

Set Range:1—250S

Unit:1

Factory Setting:30S

This parameter is set for the lasting time under the stopping voltage level before entering into sleep mode. For details refer to the following description.

\*CD117 Wakeup Voltage Level

Set Range:1—150%

Unit:1

Factory Setting:80%

This parameter is set for the wakeup voltage level from sleep to wakeup.  
Wakeup Voltage=PID Target Value×CD117

\*CD118 Sleep Frequency

Set Range:0.00—400.00

Unit: 0.01

Factory Setting:20.00

This parameter is set for the lowest operating frequency entering into sleep mode.

\*CD119 Lasting Time of Sleep Frequency

Set Range:1—250S

Unit:1

Factory Setting:20S

This parameter is set for the lasting time to run at sleep frequency when entering into sleep mode.

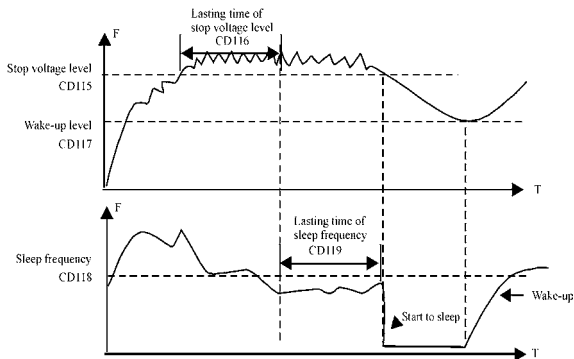

The following is the block diagram of multi pumps operation:

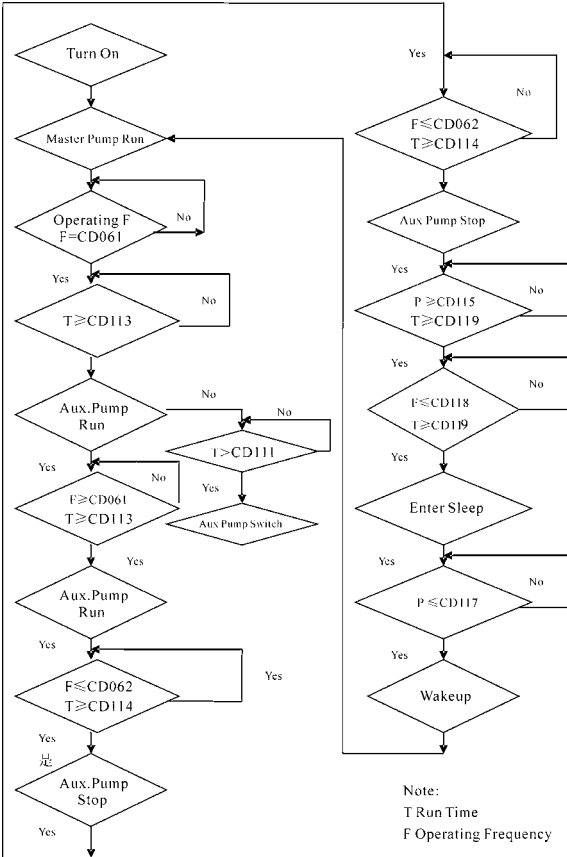

**CD120 Over-voltage Stall Prevention**

Set Range:0—1

Unit:1

Factory Setting:1

0:Over-voltage stall prevention invalid

1:Over-voltage stall prevention valid.

When the inverter is in deceleration, due to the effect of load inertia, the motor will produce a return energy to the inverter and cause the DC voltage of the inverter to increase. So when the function of over-voltage stall prevention is started, if the DC voltage of the inverter becomes too high, the inverter will stop decelerating till the voltage at DC decreases below the set value, then the inverter will go on to decelerate and the ramp-down time will be extended automatically.

**CD121 Stall Prevention Level at Ramp-up**

Set Range:0—200%

Unit:1%

Factory Setting:150

When the inverter is in ramp-up, due to overload or too short ramp-up time, the output current of the inverter will go up quickly and exceed the set standard level. When this happens, the inverter will stop accelerating. When the current returns under its set value, the inverter will go on to accelerate.

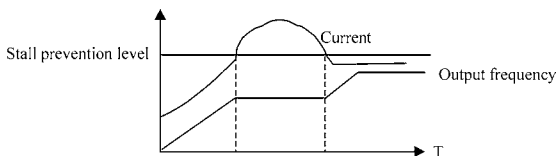

100% current is the rated current of the motor. When this parameter is set to 0, the stall prevention function is invalid.

**CD122 Stall Prevention Level at Constant Speed**

Set Range:0—200%

Unit:1%

Factory Setting:0

When the inverter is running at constant speed, due to load fluctuation and other reasons, the current will increase. When the current exceeds its set standard value, the inverter will lower the output frequency. When the output current returns to its normal range, the inverter will accelerate again to its set frequency.

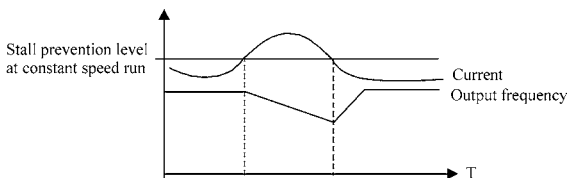

100% current is the Rated Current of the motor. When this parameter is set to 0 the stall prevention function is invalid.

CD123 Stall Prevention Level at Deceleration

Set Range:0—232%

Unit:1

Factory Setting:0

Refer to CD120.

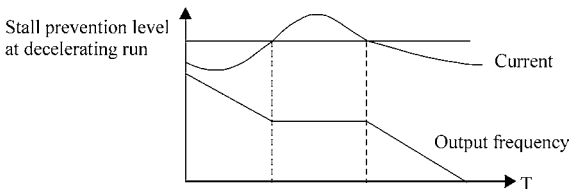

100% current is the rated current of the motor.

CD124 Over-torque Detect Mode

Set Range:0—3

Unit:1

Factory Setting:0

0:When reaching the frequency it starts to detect over-torque and when over-torque is detected it continues to run.

1:When reaching the frequency it starts to detect over-torque and when over-torque is detected it stop running.

2:It detects over-torque during running and when over-torque is detected it continues to run.

3:It detects over-torque during running and when over-torque is detected it stop running.

CD125 Over-torque Detect Level

Set Range:0—200%

Unit:1%

Factory Setting:0

When the output current exceeds the over-torque detection level and also exceeds half of the set time of over-torque detection (factory setting: 1.0s),

the over-torque detection will indicate, and the corresponding multi-function alarm contact will act. When it exceeds the set time, the inverter will turn to self-protection. When this parameter is set to 0, the over-torque detection will be invalid

**CD126 Over-torque Detect Time**  
Set Range:0.1—20.0s      Unit:0.1s      Factory Setting:1.0

When the inverter detects that the output current has exceeded the motor current set value, the inverter begins to calculate the over-torque time. When the over-torque time has exceeded half of the set detect time, the corresponding multi-function output contact will act, and produce the over-torque alarm, while the inverter will keep running. When the over-torque time has exceeded the set detect time (set by CD126), the inverter will turn to self-protection, display the fault information and stop output.  
For the related parameters refer to CD125.

**CD127 Decel. Time for Stall Prevention at Constant Speed**      Factory Setting:5.0

When the inverter is used for the loads of kinds of fan and pump CD122 can be set to 120. When the current of the inverter is greater than 120% the output frequency will decrease and the current will also decrease accordingly. After the current returns to normal the frequency will return to normal slowly, so as to achieve the stall prevention function. The decreasing speed of the frequency is determined by CD127. For the Related parameters refer to CD 122.

**CD128 Fault Restart Time**      Factory Setting:1.0 s

When the inverter is set for fault restart and if it has a fault trip with the time exceeding the set value of CD128 the inverter will restart. When using this function pay more attention to the safety.

**CD129 Voltage Rise Time during frequency track**      Factory Setting:5

When the starting mode of the inverter is set to frequency track there is a process of voltage rise during the frequency track. When the voltage is rising rapidly the current will be higher and the tracking process will be faster. When the voltage is rising slowly the current will be lower and the tracking process will be slower. In general practice this value of CD129 is set lower for the inverter of smaller power and set higher for the inverter of larger power.



CD130 Rated Motor Voltage      Unit:0.1V      Factory Setting:\*

It is set according to the rated voltage value of the nameplate of the motor. For the inverters of 230V class the factory setting is 220, while for the inverters of 400 V class the factory setting is 380.

CD131 Rated Motor Current      Unit:0.1A      Factory Setting:\*

It is set according to the rated value of the nameplate of the motor. This parameter can be used to restrict the output current of the inverter to prevent over-current and protect the motor. If the current of the motor has exceeded this value the inverter of AC motor will turn to self-protection.

CD132 Motor Pole Number  
Set Range:02—60      Unit:1      Factory Setting:04

This parameter is set for the number of the motor's pole according to the nameplate of the motor.

CD133 Rated Motor Revolution  
Set Range:0—9999      Unit:1r/min      Factory Setting:1440

This is set according to the actual revolution of the motor. The displayed value is the same as this set value. It can be used as a monitoring parameter, which is convenient to the user. This set value corresponds to the revolution at 50Hz.

CD134 Motor No-load Current  
Set Range:0—100      Unit:1      Factory Setting:40

The setting of motor no-load current will affect the value of slip compensation. The current is 100% of the rated current of the motor.

CD135 Motor Slip Compensation  
Set Range:0—1000      Unit:1      Factory Setting:0

When the inverter drives the motor the slip becomes bigger due to the increase of load. This parameter can be set for slip compensation to decrease the slip and make the running speed of the motor closer to the synchronous revolution.

CD136 Over pressure Setting  
Set Range:0.00-99.99Kg      Unit:0.01Kg      Factory Setting:10.00

The system will stop if the value of feedback pressure is greater than that of over pressure setting for more than over pressure delay time

CD137 Over pressure delay time  
Set Range:0-250s Unit:1s Factory Setting:5

If the value of the feedback is greater than that of over pressure setting, the delay time of the system is decided by setting the over pressure delay time.

CD138 Over pressure automatic resume  
Set Range:0.00-9.99Kg Unit:0.01Kg Factory Setting:1.00

After the over pressure fault occurring, if the system pressure is smaller than the value of automatic resume for more than the automatic resume time of over pressure, the system will restart automatically.

CD139 automatic resume time  
Set Range: 0-250s Unit:1s Factory Setting:5

If the value of the feedback pressure is smaller than that of over pressure automatic resume, the delay time of the system restarting is decided by setting the automatic resume time of over pressure.

CD140 DC Braking Voltage Level  
Set Range:0.0—20.0% Unit:0.1% Factory Setting:2.0

This parameter is set for the DC braking voltage to the motor at start and stop. It can be adjusted for different braking voltage. When adjusting the parameter it must be increased slowly from lower value to high value until the sufficient braking torque is achieved.

The voltage at maximum frequency is 100% voltage.

CD141 DC Braking Time at Start  
Set Range:0.0—25.0S Unit:0.1S Factory Setting:0.0

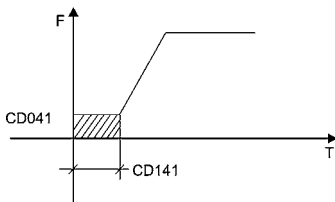

This parameter is set for DC Braking at start and the lasting time of DC Braking current to the motor. If it is set to zero it means DC braking is invalid.

DC braking at start is

normally used in the application, in which the load is movable when the machine is at stop, such as windmill. Because of the load existing before the inverter drives, the motor is often in coasting with an uncertain rotation direction. So the DC braking can be executed before starting the motor to prevent the inverter from tripping.

This setting is valid only when CD031 is set to 0. For the related parameters refer to CD031, CD140 and CD041.

**CD142 DC Braking Time at stop**

Set Range:0.0—25.0

Unit:0.1S

Factory Setting:0.0

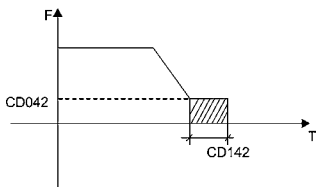

Note: When this parameter is set to any non-zero value it starts DC brake at stop and sends the DC braking time to the motor. DC braking at stop is often used for a high-level stop or positioning control. When this parameter is set to zero it closes DC braking at stop.

This setting is valid when CD032 is set to 0. For the related parameters refer to CD032, CD042 and CD140.

**CD143 Frequency Track Time**

Set Range:0.1—20.0S

Unit:0.1S

Factory Setting:5.0

This parameter is set as frequency track time when the inverter is started by frequency track after an external abnormality or temporary power breakdown. For starting or stopping of some large inertia load, if restarting a machine after its complete stop, it will waste much time because of its large inertia of load. But if the frequency track is started, it is not necessary to wait for the machine to come to a full stop for restart. The inverter will trace the frequency from high to low with the set frequency. After searching it will continue to accelerate to reach the set frequency.

**CD144 Current Level for Frequency Track**

Set Range:0—200%

Unit:1%

Factory Setting:150

When the inverter is tracing the frequency this set value is taken as the level for output current. When the output current is higher than this level

the inverter will decrease the frequency to restore the current below the level and then it will execute the frequency track again.

**CD145 Restart after Instantaneous Stop**

Set Range:0—1

Unit:1

Factory Setting:0

0: Invalid, i.e. the inverter will not restart after an instantaneous power breakdown.

1: Start by frequency track. Refer to CD143.

**CD146 Allowable Power-Breakdown Time**

Set Range:0.1—5.0S

Unit:0.1S

Factory Setting:0.5

This parameter is set for the maximum allowable power failure time. If exceeding the set time the inverter will continue to stop output after power on. To restart the inverter it needs to follow the general starting procedures.

**CD147 Number of Abnormal Restart**

Set Range:0—10

Unit:1

Factory Setting:0

After the abnormal conditions (such as over-current and over-voltage) happens the inverter will automatically reset and restart. If the starting mode is set to normal mode it will start according to the normal procedures. If it is set to start by frequency track it will start in the frequency track mode. After starting it will restore the set number again if there is no more abnormality happened within 60 seconds. If there is still any error and it reaches the set number the inverter will stop output. It can only be started after reset. When CD147 is set to zero the inverter will not carry out the functions of automatic reset and restart.

**CD148 Auto Voltage Regulation**

Set Range:0—1

Unit:1

Factory Setting:1

0:Invalid

1:Valid

When the input power is not stable and if the voltage is too high the operation of the motor with the power exceeding the rated voltage will cause increase of the temperature of the motor, damage of its insulation and unstable output torque. This auto voltage regulation can automatically stabilize the output voltage within the rated voltage range of the motor under the condition of unstable output power supply

When this function is set to invalid the output voltage will fluctuate.

**CD149 Auto Energy Saving**

Set Range:0.0—20.0%    Unit: 0.1%    Factory Setting: 0.0

When it is set to zero this function is invalid. When Auto energy saving function is started the inverter will run at the full voltage during ramp-up or -down. During the operation at constant speed the inverter can automatically calculate the optimum voltage value according to the power of load and supply power to the load to achieve the goal of energy saving.

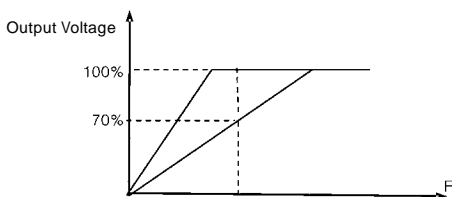

Auto energy saving can reduce the normal output voltage by max 30%. For the load with frequent changes or closing to full load, this function is not suitable.

**\*CD150 Proportional Constant (P)**

\*\*

Set Range:0.0~1000.0%    Unit:0.1%    Factory Setting:100.0%

This proportional constant is set for the error value gain. In case of  $I=0$ ,  $D=0$ , it is only for proportional control.

**\*CD151 Integral Time (I)**

\*\*

Set Range:0.0~1000.0s    Unit:0.1s    Factory Setting:5.0s

The integral time (I) is set for the responding speed for PID. The larger the I value is set the slower the responding speed will be. To the contrary, if the responding speed is quick but the integral time value is set too small, it will cause oscillation.

**\*CD152 Differential Time (D)**

\*\*

Set Range:0.00~10.00s    Unit:0.01s    Factory Setting:0

This differential time (D) is set for the depression operation of PID. The larger the D value is, the more obvious the depression operation will be. When D is set to zero, this function is invalid.

\*CD153 Target Value \*\*  
 Set Range:0.00~99.99Kg Unit:0.01kg Factory Setting:5.00

This target value can be set through external voltage signal or the digital operator.99.99Kg get value is corresponding to the analog frequency at +10V.

PID closed-loop control is usually used in the process control with physical quantity not changing fast, such as the controls of pressure and temperature, etc. The feedback signal is usually taken from temperature transmitter, or pressure transmitter, etc. Under PID control, the feedback signal input path is the analog current signal of 4-20mA.

PID closed-loop control is valid when Multi-input PID is started.

PID Control Block Diagram:

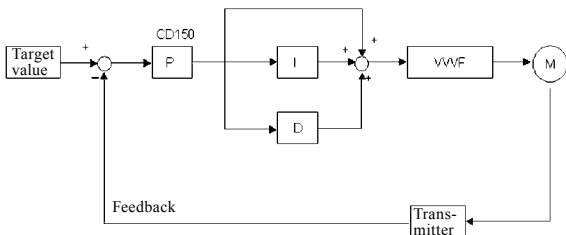

General operating methods of PID control:

- (1) Choose the correct transmitter (with the output specification of standard current signal 4-20mA).
- (2) Set the right target value.
- (3) If the output does not have oscillation, increase the proportional constant (P).
- (4) If the output does not have oscillation, decrease the integral time (Ti).
- (5) If the output do not have oscillation, increase the differential time (Td).
- (6) Concrete applications can be referred to the example application descriptions in Appendix 1.

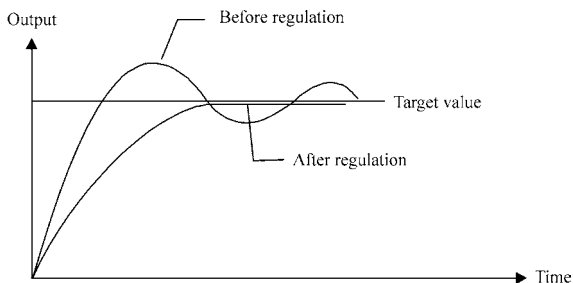

### 1. Suppress the Over Output

a: Decrease the differential time (D value)

b: Increase the integral time (I value)

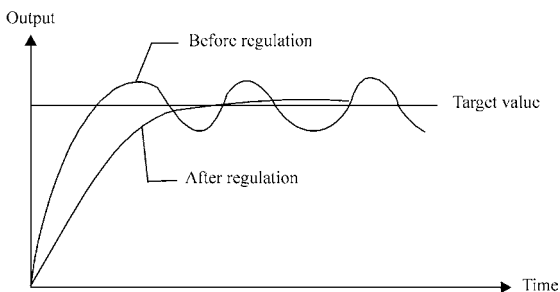

### 2. Suppress the oscillation

a: Decrease the differential time (D value) or set it to zero.

b: Decrease Proportional Constant (P value)

|        |                  |                          |
|--------|------------------|--------------------------|
| *CD154 | PID Target Value | **                       |
|        | Set Range: 0—1   | Unit: Factory Setting: 0 |

The target value can be set through the selection of the panel or external analog. The external analog is 0~10V signal or given by the potentiometer.

When CD154=0, the target value of PID is the value set by CD153.

When CD154=1, the target value of PID =  $CD159 \times \text{Input Voltage (VI)} / 10V$

\*CD155 PID Upper Limit \*\*  
Set Range:0—100% Unit: Factory Setting:100%

When PID feedback value is more than the set value of CD155 the corresponding multi-output will act and the inverter will not stop.

\*CD156 PID Lower Limit \*\*  
Set Range:0—100% Unit: Factory Setting:0%

When PID feedback value is less than the set value of CD156 the corresponding multi-output will act and the inverter will not stop.

CD157 PID feedback \*\*  
Set Range:0—3 Unit:1 Factory setting:0

0: 4~20mA (AI) 1: 0~10V(VI)

2: 0~10V (RI) 3: 4~20mA (AI) and 0~10V (RI) stacked

CD158 Reserved

CD159 Sensor Range \*\*  
Set Range:0.00—99.99Kg Unit:0.01 Factory Setting:10.00

CD160 Communication Addresses  
Set Range:00—250 Unit: Factory Setting:00

When the inverter is set for RS-485 Communication interface control, each of the inverters will be set for its individual identification number through CD160.

00:No communication function.

01~250:Address for the inverters

CD161 Communication Baud Rate  
Set Range: 0—3 Unit: Factory Setting:1

0:4800 b/s 1:9600 b/s 2:19200 b/s 3:34800 b/s

CD162 Communication Data Method  
Set Range: Unit: Factory Setting:0

0:8N1 For ASCII

1:8E1 For ASCII

2:8O1 For ASCII

3:8N1 For RTU

4:8E1 For RTU

5:8O1 For RTU

CD163—CD166 Reserved



## HOLIP MODBUS Communication Protocol

When using the RS485 communication interface, each of the inverters must be set for its own address so that the computer can use this individual address to carry out the control.

1: The communication protocol has two kinds of control mode:

- (1) RTU (Remote Terminal Unit) mode
- (2) ASCII (American Standard Code for information interchange) mode

Information of codes:

RTU mode: Each of 8-bit data is composed of two 4-bit (hexadecimal), for example: 64H

ASCII mode: Each of 8-bit data is composed of two ASCII byte, for example:

One 1-bit data 64H (hexadecimal) is composed of ASCII byte "64", included "6" (36H) and "4" (34H).

| Byte       | 0   | 1   | 2   | 3   | 4   | 5   | 6   | 7   |
|------------|-----|-----|-----|-----|-----|-----|-----|-----|
| ASCII code | 30H | 31H | 32H | 33H | 34H | 35H | 36H | 37H |

| Byte       | 8   | 9   | A   | B   | C   | D   | E   | F   |
|------------|-----|-----|-----|-----|-----|-----|-----|-----|
| ASCII Code | 38H | 39H | 41H | 42H | 43H | 44H | 45H | 46H |

### 2: Communication Data Method

1) 8N1 For ASCII CD162=0

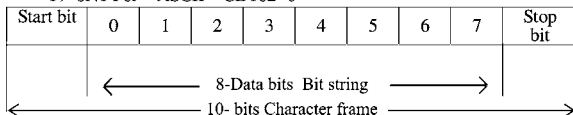

2) 8E1 For ASCII CD162=1

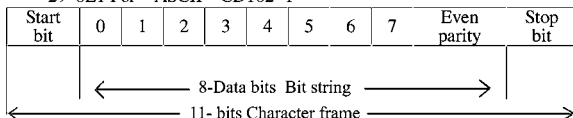

3) 8O1 For ASCII CD162=2

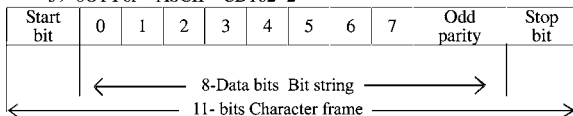

## 4) 8N1 For RTu CD162=3

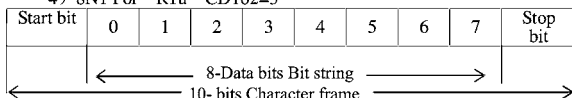

## 5) 8E1 For RTu CD162=4

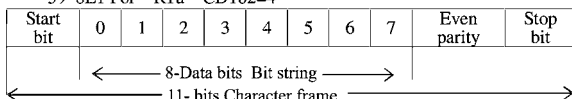

## 6) 8O1 For RTU CD163=5

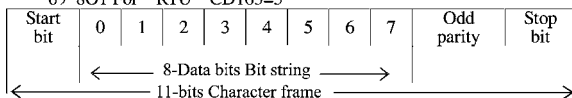

## 3: Communication Document Formats

## 3.1 ASCII Mode

## Communication Document Forms

|                     |      |      |     |   |     |                             |
|---------------------|------|------|-----|---|-----|-----------------------------|
| STX<br>“.”<br>(3AH) | ADDR | FUNC | LEN | DATA<br>(n-1)<br>...<br>DATA <sub>0</sub> | CRC | END<br>CR (0DH)<br>LF (0AH) |
|---------------------|------|------|-----|---|-----|-----------------------------|

(1) STX:Starting unit“.”(3AH)

(2) ADDR communication address,8-bit data is composed of two ASCII byte.

00:Broadcast mode is MODBUS

01~250:Address of the corresponding inverters.

(3) FUNC:Function code 8-bit data is composed of two ASCII byte.

01:FUNC READ, Read the data of function code

02:FUNC WRIT, write the data of function code

03:Write control data

04:Read control status data

05:Write inverter frequency data

06:Reserved

07:Reserved

08:Loop test

a:Read function code data

Format:

ADDR 01 LEN FUNC Data

ADDR=0 means no answer

ADDR≠0 means a reply from inverter of this address

When inverter reply normal, the format as follows:

ADDR 01 LEN FUNC Data

If DATA is one word, the LEN=3, If DATA is one byte, the LEN=2 .

When inverter has no this function code or reply no effect, the format as follows:

ADDR 81H 01 FUNC

b:Write function code data

Format:

ADDR 02 LEN FUNC Data

ADDR=0 for broadcast, it write to all inverter, but no reply.

ADDR≠0, set data and reply from inverter of this address.

When the setting is incorrect or the inverter does not have this function, the format returned is as follows:

ADDR 81H 01 FUNC

c:Control commands

Format:

ADDR 03 LEN CNTR

ADDR=0 for broadcast, it write to all inverter, but no reply

ADDR≠0, reply and return.

CNTR

|      |      |     |     |      |     |     |     |
|------|------|-----|-----|------|-----|-----|-----|
| 7    | 6    | 5   | 4   | 3    | 2   | 1   | 0   |
| jogr | jogf | jog | r/f | stop | rev | for | run |

When the setting is correct it will return to present control status.

Format:ADDR 03 LEN CNST

CNST

|             |         |     |         |         |     |     |     |
|-------------|---------|-----|---------|---------|-----|-----|-----|
| 7           | 6       | 5   | 4       | 3       | 2   | 1   | 0   |
| Track start | Braking | r/f | jogging | running | r/f | jog | run |

When the check is not correct,

ADDR 83H 01 CNST

d:Read status value

Format:

ADDR 04 01 CFG

ADDR=0, no reply

ADDR≠0, reply.

CFG=0~7, reply single data

0:Set F 1:Out F 2:Out A 3:RoTT

4:DCV 5:ACV 6:Cont 7:Tmp

For example: read agreed frequency

Send:01 04 03 00 CRC

Return:01 04 03 13 88 CRC

In which, 13 88 are data

13 for high order, while 88 for low order.

(4)LEN:data length, It means the length of  $D_{(n-1)}...D_0$ , Length set: when one word, LEN=3, when one byte or <1byte, LEN=2.

(5)DATA:<Data characters> data content. 2n ASCII compose n bytes, it have fifty ASCII at most.

(6) LRC:longitudinal redundancy check

ASCII mode: Get LRC methods is that add ADDR to the last data, if the result is more than 256,then the result subtract 256 until the result is less than 256 (if the result is 128H, take 28H), then 100H subtract the result get LRC.

(7) For example: write 30.00Hz to inverter of 01(write to CD000)

| STX | ADDR    | FUNC    | LEN     | DATA                       | LRC        | END          |
|-----|---------|---------|---------|----------------------------|------------|--------------|
| “.” | “0”“1”  | “0”“2”  | “0”“3”  | “0”“0”“0”“B”<br>“B”8”      | “3”“7”     | “CR”<br>“LF” |
| 3AH | 30H 31H | 30H 32H | 30H 33H | 30H 30H 30H<br>42H 42H 38H | 33H<br>37H | 0DH<br>0AH   |

Calculate LRC:  $01H+02H+03H+00H+0BH+B8H=C9H$

C9H subtracted from 100H: 37H

So the sent data is following:3AH 30H 31H 30H 32H 30H 33H 30H 30H 30H  
42H 42H 38H 33H 37H 0DH 0AH

### 3.2 RTU Mode

| Quiet | ADDR | FUNC | LEN | $D_{(n-1)}\sim D_0$ | CRC | Quiet |
|-------|------|------|-----|---------------------|-----|-------|
| >50ms |      |      |     |                     |     | >50ms |

(1) Quiet: the time of no data is more than 50 ms

(2) ADDR: Communication address, 8-bit data

(3) FUNC: Function code, 8-bit data, refer to 3.1-3

(4) LEN: Data length, the length of  $D_{(n-1)}\sim D_0$

(5) DATA: data content,  $n*8$ -bit

(6) LRC: Longitudinal Redundancy Check

RTU mode: get CRC (cyclical Redundancy Check) .

The CRC calculation method is following:

(1) make a 16-bit register and set value 0FFFFH(call CRC register)

- (2) done first byte of data Exclusive OR with low byte of 16-bit CRC register and save the result to CRC register
- (3) done 1 bit right shift with CRC register and fill zero to left bit, then check low bit of CRC register.
- (4) if the low bit is zero, then do repeat step3, else CRC register do Exclusive OR with 0A001H.
- (5) done repeat step 3 and 4, until CRC register done right shift 8 times, then the byte is fully done.
- (6) done repeat step 2 to 5 for the next byte of data, until process completely all data. The last data of CRC register is CRC value. When send CRC value in command data, low bytes must change the sequence with high bytes, i.e. low bytes will be sent first.
- (7) Example 1: Write 30.00Hz to inverter of 01

Command data

| ADDR | FUNC | LEN | DATA        | CRC     |
|------|------|-----|-------------|---------|
| 01H  | 02H  | 03H | 00H 0BH B8H | 7FH 0CH |

Sent data:01H 02H 03H 00H 0BH B8H 7FH 0CH

- (8) Example 2:

The following is that get CRC value with C language. The function has two parameters:

Unsigned char data ← the point of data buffer

Unsigned char length ← number of data buffer

This function will send back the CRC value with unsigned integer format.

```

Unsigned int crc_chk (unsigned char data, unsigned char length)
{
int j;
unsigned int reg_crc=0xffff;
while (length--){
reg_crc^=*data++;
for(j=0;j<8;j++){
if(reg_crc&0x01){/*LSB(b0)=1*/
reg_crc=(reg_crc>>1)^0xa001;
}else{
reg_crc=reg_crc>>1;
}
}
}
return reg_crc;
}

```

CD167 Display Items  
Set Range:0—31                      Unit:1                      Factory Setting:0

This parameter is only valid when Bit 2 is set to 1 in CD168. For the details refer to CD168.

- 0: Inverter Temperature
- 1: Counter Value
- 2: PID Target Value
- 3: PID Feedback Value
- 4: Present running time of power up (Unit: Hour)
- 5: Total running time of power up (Unit: Hour)

CD168 Display Items Open  
Set Range:0—7                      Unit:1                      Factory Setting:0

This parameter is set for selection of displaying of DC voltage, AC voltage and other items so that the customer can monitor and view them in sequence through the switch key.

It can be set first in the binary 3 bits mode, and then converted to a decimal value.

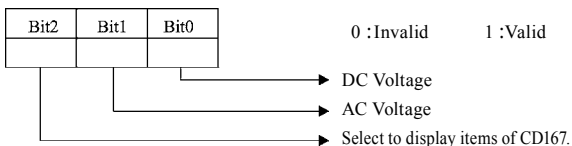

In the contents displayed the factory setting is to show output frequency, set frequency, output current and output revolution through the switch key. If it is necessary to view and monitor other items they can be set through CD167 and CD168.

CD169 Voltage Rating of Inverter    Unit:1V                      Factory Setting:\*

Factory setting is depending on the model. It can be observed, but not set.

CD170 Rated Current of Inverter    Unit:1A                      Factory Setting:\*

It is depending on the model and can't be changed.

CD171 Software Version                      Factory Setting:\*

It can be observed, but not set.

|       |                |                       |
|-------|----------------|-----------------------|
| CD172 | Fault Record 1 | Factory Setting:_____ |
| CD173 | Fault Record 2 | Factory Setting:_____ |
| CD174 | Fault Record 3 | Factory Setting:_____ |
| CD175 | Fault Record 4 | Factory Setting:_____ |

When it has no fault record it shows ——. After access to this parameter the fault display can be checked.

|                |             |        |                   |    |
|----------------|-------------|--------|-------------------|----|
| CD176          | Fault Clear | Unit:1 | Factory Setting:0 | ** |
| Set Range:0—10 |             |        |                   |    |

01 is for fault clear. Others have no function.

|               |                |        |                   |
|---------------|----------------|--------|-------------------|
| CD177         | Inverter Model | Unit:1 | Factory Setting:0 |
| Set Range:0—1 |                |        |                   |

0:Constant torque 1:For kinds of fan. It can be observed, but not changed.

|       |                             |        |                   |
|-------|-----------------------------|--------|-------------------|
| CD178 | Inverter Frequency Standard | Unit:1 | Factory Setting:* |
|-------|-----------------------------|--------|-------------------|

0:50Hz 1:60Hz It is factory setting. It can be observed, but not set.

|       |                  |                   |
|-------|------------------|-------------------|
| CD179 | Manufacture date | Factory Setting:* |
|-------|------------------|-------------------|

|   |   |   |   |   |
|---|---|---|---|---|
| 5 | 4 | 3 | 2 | 1 |
|---|---|---|---|---|

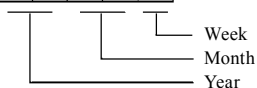

It is factory setting. It can be observed, but not set.

|       |            |                   |
|-------|------------|-------------------|
| CD180 | Serial No. | Factory Setting:* |
|-------|------------|-------------------|

It is factory setting. It can be observed, but not set.

|             |          |
|-------------|----------|
| CD181~CD250 | Reserved |
|-------------|----------|

Note:

\* means the said parameter has a variety of set values or should be set specifically according to concrete conditions.

\*\* means the said parameter can be set during the operation.

## **X. Care & Maintenance, Fault Information and Troubleshooting**

Periodical maintenances and inspections will keep your inverter in its normal state for long time.

### **1. Precautions about Inspection and Maintenance**

- Be sure to turn off the power supply to the inverter □ R.S.T □ first before the inspection and maintenance.
- After confirming the main circuit power supply has been turned off and the display has disappeared, wait until the internal indicator lamp for high voltage goes out before performing the inspection and maintenance.
- During the inspection, do not pull out or wrongly distribute the internal power supply, wires and cables. Otherwise it will cause malfunction or damage to the inverter.
- Do not leave any screw or other part inside the inverter during the installation, or it will result in the short circuit of circuit board.
- Keep the inverter clean, free from dust, oil mist and moisture after the installation.

### **2. Periodical Inspection and Maintenance items**

- Check whether the power supply voltage conforms to the rated voltage of the inverter.  
(Pay special attention to that whether there is any damage on the power supply wires and the motor.)
- Check whether the wiring terminals and the connectors are tight  
(Check whether the power supply wires and terminal connection wires have any broken strand).
- Check whether there is dust, iron filings or corrosive fluid in the inverter.
- Measuring the insulation impedance of the inverter is forbidden.
- Examine the output voltage, output current and output frequency of the inverter.  
(The measuring results should not have too big difference.)
- Check whether the ambient temperature of the inverter is between -5°C and 40°C and whether the installation environment has good ventilation.
- Check whether the humidity is kept below 90% (without condensation).



- Check whether the motor makes unusual noises or abnormal vibration in running.  
(The inverter should not be installed in a place with high vibration.)
- Please make periodical cleaning of vent holes.

### 3. Fault Indication and Troubleshooting

The inverter of HLP series is relatively perfective with the protection functions of overload, inter-phase short circuit, earth short circuit, under-voltage, overheating and over-current, etc. When a protection function happens with the inverter please check the reasons of faults according to the information listed in the table below. The inverter can be restarted after the disposal. If the fault cannot be disposed please contact the local distributor.

| Fault Display    | Fault Contents & Description                  | Disposal methods   |
|------------------|---|--|
| E.OC.A           | Over-current during ramp-up                   | 1: Check whether the motor has got short circuit or partial short circuit and whether the insulation of output wire is good.<br>2: Extend the ramp-up time.<br>3: The configuration of the inverter is not reasonable. The inverter's capacity should be increased.<br>4: Decrease the torque and increase the set value.  |
| E.OC.n           | Over-current at constant speed                | 1: Check whether the motor has got short circuit and whether the insulation of the output wires is good.<br>2: Check whether the motor is blocked and whether there is a sudden change of mechanical load.<br>3: Check whether the inverter's capacity is too small and increase its capacity.<br>4: Check whether there is a sudden change in the power supply voltage. |
| E.OC.d<br>E.OC.S | Over-current at decel<br>Over-current at stop | 1: Check whether the insulation of the output wires is good and whether the motor has got short circuit.<br>2: Extend the Ramp-down Time.<br>3: Replace it with an inverter of larger capacity.<br>4: DC braking is too high. Decrease DC braking.<br>5: The inverter has failure. Please send it to the factory for repair.   |

| Fault Display                        | Fault Contents & Description   | Disposal methods   |
|--------------------------------------|--|--|
| E.GF.S<br>E.GF.a<br>E.GF.n<br>E.GF.d | Short circuit to earth   | 1: Check whether the connection wire of the motor has got short circuit.<br>2: Check whether the insulation of the output wires is good.<br>3: Please send it for repair.  |
| E.ou.S<br>E.ou.a<br>E.ou.n<br>E.ou.d | Over-voltage at stop<br>Over-voltage at accel<br>Over-voltage at constant speed<br>Over-voltage at decel | 1: Extend the Ramp-down Time or add a braking resistor.<br>2: Improve the mains supply voltage and check whether there is any sudden change in the voltage.  |
| E.Lu.s<br>E.Lu.A<br>E.Lu.n<br>E.Lu.d | Low voltage  | 1: Check whether the input voltage is normal.<br>2: Check whether there is sudden change in load.<br>3: Check whether there is any phase missing.  |
| E.OH.S<br>E.OH.A<br>E.OH.n<br>E.OH.d | Overheat of inverter   | 1: Check whether the fan is blocked and whether there is any foreign matter stuck in the cooling fins.<br>2: Check whether the ambient temperature is normal.<br>3: Check whether there is enough space for ventilation and good air convection.   |
| E.OL.A<br>E.OL.n<br>E.OL.d           | Inverter overload<br>150% Per minute   | 1: Check whether the capacity of the inverter is lower. Otherwise it should be increased.<br>2: Check whether there is any jamming in the mechanical load.<br>3: The setting of V/F curve is bad. Set it again.  |
| E.OA.A<br>E.OA.n<br>E.OA.d           | Motor overload<br>150% Per minute  | 1: Check whether there is any sudden change in the mechanical load.<br>2: The equipped motor is too small.<br>3: The motor is hot and the insulation becomes bad.<br>4: Check whether the voltage has big fluctuation.<br>5: Check whether there is any phase missing.<br>6: The mechanical load is increased. |
| E.OT.A<br>E.OT.n<br>E.OT.d           | Motor over-torque  | 1: Check whether there is any fluctuation in the mechanical load.<br>2: Check whether the equipped motor is smaller.   |

| Fault Display                        | Fault Contents & Description                                     | Disposal methods            |
|--------------------------------------|--|-----------------------------|
| E.bS.A<br>E.bS.n<br>E.bS.d<br>E.bS.S | No feedback from auxiliary coil of the electromagnetic contactor | Please contact the factory. |
| E.bT.A<br>E.bT.n<br>E.bT.d           | Braking transistor damage  | Please send it for repair.  |
| E.EC.S<br>E.EC.n<br>E.EC.d<br>E.EC.A | CPU fault  | Please contact the factory. |
| E.EE.S<br>E.EE.n<br>E.EE.d<br>E.EE.A | E2Prom fault   | Please contact the factory. |

|     |                        |                                 |
|-----|------------------------|---------------------------------|
| Er  | External interferences | Isolate the interference source |
| ES  | Emergency Stop         | In Emergency Stop               |
| 20  | 4-20mA wire broken     | Join the broken wires           |
| Pr  | Setting error          | Correct the setting             |
| DCb | DC braking status      | In DC braking                   |

Note: (1) Fault Code Form as follows:

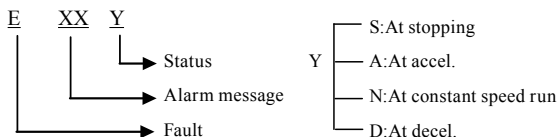

(2) Code Comparison Table:

|          |          |          |          |          |          |          |          |          |          |          |          |          |          |          |          |          |
|----------|----------|----------|----------|----------|----------|----------|----------|----------|----------|----------|----------|----------|----------|----------|----------|----------|
| A        | B        | C        | D        | E        | F        | G        | H        | O        | S        | N        | L        | T        | P        | R        | U        | 2        |
| <i>A</i> | <i>b</i> | <i>c</i> | <i>d</i> | <i>e</i> | <i>f</i> | <i>g</i> | <i>h</i> | <i>o</i> | <i>s</i> | <i>n</i> | <i>l</i> | <i>t</i> | <i>p</i> | <i>r</i> | <i>u</i> | <i>2</i> |

## 4. Faults and Analysis

(1) When RUN key is pressed, the motor does not run.

1) The setting of operation mode is wrong, i.e., under the operation mode of external control terminals, the inverter is started by the digital operator or under the operation mode of the digital operator it is started

by the external control terminals.

- 2)The frequency reference is too low or not set.
- 3)The peripheral wiring is wrong. For example, the setting of wiring of two-wire system and three-wire system and other related parameters have errors.
- 4)The setting of multi-function terminals is wrong (in the external control).
- 5)The inverter is in the fault protection.
- 6)The motor fails.
- 7)The inverter fails.

(2)The parameters cannot be set.

- 1)Password locks. Please decrypt it first before resetting.
- 2)The inverter is in running.
- 3)The connection of the connecting parts is abnormal. The communication of the digital operator is abnormal. Take out the operator after power-off and then mount it again for a trial.

(3)The motor cannot rotate reverse.

Reverse rotation is disabled.

(4)The motor rotates in the opposite direction.

The output line is wrongly connected. Please change any two lines of U.V.W over.

(5)The deceleration of the motor is too slow.

- 1)The setting of Ramp-down Time is too long. Decrease Ramp-down Time.
- 2)Add a braking resistor.
- 3)Add a DC brake.

(6)Over-heat of the motor

- 1)The load is too large. The actual torque has exceeded the rated torque of the motor. It is recommended to increase the capacity of the motor.
- 2)The ambient temperature is too high. In a place with higher temperature the motor will be burn out. Please decrease the temperature around the motor.
- 3)The phase to phase withstand voltage of the motor is insufficient. The switch actions of the inverter will make the winding coil of the motor produce shock wave. Typically the maximum shock voltage will reach 3 times that of input power of the inverter. Please select a motor with higher phase to phase withstand voltage against shock than the maximum

shock voltage.

(7)The starting of the inverter interferes other control devices

- 1)Decrease the carrier frequency and reduce the number of actions of internal switches.
- 2)Install a noise filter at the power input of the inverter.
- 3)Install a noise filter at the output of the inverter.
- 4)Make correct grounding for the inverter and the motor.
- 5)Use metal conduit to tube the cable to shield it.
- 6)Make separate wiring for the main circuit wires and control wires.

(8)When the fan starts the inverter detected an over-current stall.

- 1)At start the fan rotates idly. Please set it for DC braking at start.
- 2)When DC braking at start has been set increase the DC braking value.

(9)The machine has the noise of vibration or roar

- 1)The vibration frequency of mechanical system resonates with the carrier. Adjust the carrier to avoid the point of resonance.
- 2)The vibration frequency of mechanical system resonates with the output frequency of the inverter.
  - a.Set it for skip function to avoid the point of resonance.
  - b.Put rubber vibration isolator on the base plate of motor.

## XI. Selection of Peripheral Devices and Disposition

### 1. Options

| Description   | Functions   |
|---|---|
| NFB or Ground fault interrupter for wire connection | Protect the wiring of the inverter. Be sure to install a breaker at the power. Please select a ground fault circuit interrupter against high-order harmonics. |
| Electromagnetic contactor                           | In order to prevent the braking resistor from burning out, please add an electromagnetic contactor and connect a surge absorber to the coil when using it.    |
| Surge absorber                                      | Absorb the switching surge current from the electromagnetic contactor and control relays.   |
| Isolating transformer                               | Its function of isolating the input and output of the inverter is effective to reduce the interference to other electric devices.                             |
| DC reactor  | Improve the input power factor of the inverter.   |
| AC reactor  | Improve the input power factor of the inverter and prevent the shock of surge voltage.  |
| Braking resistor, braking unit                      | Consume the regenerating energy of the motor and shorten the ramp-down time.  |

#### 1) Leakage switch

There is earth static capacity inside of the inverter and the motor as well as the input and output leads. Due to higher carrier frequency of the inverter the inverter has higher earth leakage current, especially for the inverters of large capacity series. When using a leakage switch it may sometimes result in the error action of the protective circuit. So when using a leakage switch attention should be paid to its selection and the proper reduction of carrier frequency and shortening the leads, etc.

#### 2) AC reactors

An AC reactor can constrict the high-order harmonic of input current of the inverter to improve its input power factor and prevent the shock of surge. It is recommended to use an input AC reactor under the following circumstances:

- a: Three-phase power supply is in unbalance.
- b: Any equipment with thyristor or power factor compensation unit with

switching control is connected to the same power supply.

### 3)DC reactors

It is necessary to install a DC reactor when the capacity of power supply is more than 1000 KVA or the mains power capacity is higher than the rated capacity of the inverter. A DC reactor is also needed for the case with higher demand on the improvement of power factor of power supply. This DC reactor can be used together with an AC reactor to achieve the obvious effect of decreasing high-order harmonic at input. If it is necessary to install a DC reactor please contact the local distributor.

## 2. Disposition

### 1)DC Reactors Disposition

| Inverter Model | Matched Power(W) | Rated Current(A) | Inductance(mH) |
|----------------|------------------|------------------|----------------|
| DCL-37         | 37               | 100              | 0.7            |
| DCL-45         | 45               | 120              | 0.58           |
| DCL-55         | 55               | 146              | 0.47           |
| DCL-75         | 75               | 200              | 0.35           |
| DCL-90         | 90               | 238              | 0.29           |
| DCL-110        | 110              | 291              | 0.24           |
| DCL-132        | 132              | 326              | 0.215          |
| DCL-160        | 160              | 395              | 0.177          |
| DCL-200        | 200              | 494              | 0.142          |
| DCL-220        | 220              | 557              | 0.126          |
| DCL-280        | 280              | 700              | 0.10           |
| DCL-300        | 300              | 800              | 0.08           |
| DCL-315        | 315              | 800              | 0.08           |
| DCL-345        | 345              | 660              | 0.07           |
| DCL-375        | 375              | 715              | 0.064          |
| DCL-400        | 400              | 765              | 0.058          |
| DCL-415        | 415              | 795              | 0.053          |

### Connection

- ① Remove the jumpers of P and P1 terminals.
- ② Connect DC reactor to Terminals P and P1 as shown in the following diagram:

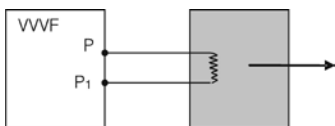
**DC Reactor**

Note: HLP inverter of above 45KW has connectors. The inverter of below 45KW must not be connected with it.

The function of DC reactor is to restrict the AC component stacked with DC reactor to a specified value to suppress the mains harmonics and improve the power factor of the inverter.

**2)AC Reactors Disposition**

| Inverter Model | Matched Power (W) | Rated Current(A) | Inductance(mH) |
|----------------|-------------------|------------------|----------------|
| HKSG2-24       | 11                | 24               | 0.52           |
| HKSG2-34       | 15                | 34               | 0.397          |
| HKSG2-38       | 18.5              | 38               | 0.352          |
| HKSG2-50       | 22                | 50               | 0.26           |
| HKSG2-60       | 30                | 60               | 0.24           |
| HKSG2-75       | 37                | 75               | 0.235          |
| HKSG2-91       | 45                | 91               | 0.17           |
| HKSG2-112      | 55                | 112              | 0.16           |
| HKSG2-150      | 75                | 150              | 0.112          |
| HKSG2-180      | 90                | 180              | 0.10           |
| HKSG2-220      | 110               | 220              | 0.09           |
| HKSG2-265      | 132               | 265              | 0.08           |
| HKSG2-300      | 160               | 300              | 0.07           |
| HKSG2-360      | 200(185)          | 360              | 0.06           |
| HKSG2-400      | 220               | 400              | 0.05           |
| HKSG2-560      | 280               | 560              | 0.03           |
| HKSG2-640      | 315               | 640              | 0.0215         |
| HKSG2-700      | 345               | 700              | 0.019          |
| HKSG2-750      | 375               | 750              | 0.017          |
| HKSG2-800      | 400               | 800              | 0.015          |
| HKSG2-860      | 415               | 860              | 0.012          |



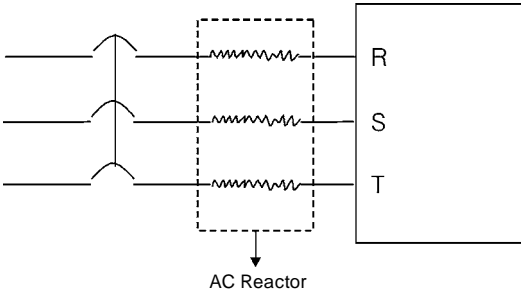

The incoming reactor is also named shift-changing reactor and it is used for the incoming wire of the mains with AC flowing inside. Its function is to suppress the harmonics of the inverter feedback to the mains.

| Inverter Model | Braking resistor Specification |          | Braking torque<br>10%ED | Special Motor KW |
|----------------|--------------------------------|----------|-------------------------|------------------|
|                | W                              | $\Omega$ |                         |                  |
| HLPP0D7523C    | 100                            | 200      | 125                     | 0.75             |
| HLPP01D523C    | 300                            | 100      | 125                     | 1.5              |
| HLPP02D223C    | 300                            | 70       | 125                     | 2.2              |
| HLPP0D7543C    | 80                             | 750      | 125                     | 0.75             |
| HLPP01D543C    | 300                            | 400      | 125                     | 1.5              |
| HLPP02D243C    | 300                            | 250      | 125                     | 2.2              |
| HLPP03D743C    | 400                            | 150      | 125                     | 3.7              |
| HLPP05D543B    | 500                            | 100      | 125                     | 5.5              |
| HLPP07D543B    | 1000                           | 75       | 125                     | 7.5              |
| HLPP001143B    | 1000                           | 50       | 125                     | 11               |
| HLPP001543B    | 1500                           | 40       | 125                     | 15               |
| HLPP18D543B    | 4800                           | 32       | 125                     | 18.5             |
| HLPP002243B    | 4800                           | 27.2     | 125                     | 22               |
| HLPP003043B    | 6000                           | 20       | 125                     | 30               |
| HLPP003743B    | 9600                           | 16       | 125                     | 37               |
| HLPP004543B    | 9600                           | 13.6     | 125                     | 45               |
| HLPP005543B    | 12000                          | 20/2     | 125                     | 55               |
| HLPP007543B    | 18000                          | 13.6/2   | 125                     | 75               |
| HLPP009043B    | 18000                          | 20/3     | 125                     | 90               |
| HLPP011043B    | 18000                          | 20/3     | 125                     | 110              |
| HLPP013243B    | 24000                          | 20/4     | 125                     | 132              |

| Inverter Model | Braking resistor Specification |          | Braking torque<br>10%ED | Special Motor KW |
|----------------|--------------------------------|----------|-------------------------|------------------|
|                | W                              | $\Omega$ |                         |                  |
| HLPP016043B    | 36000                          | 13.6/4   | 125                     | 160              |
| HLPP018543B    | 45000                          | 13.6/5   | 125                     | 185              |
| HLPP020043B    | 45000                          | 13.6/5   | 125                     | 200              |
| HLPP022043B    | 48000                          | 13.6/5   | 125                     | 220              |
| HLPP025043B    | 48000                          | 13.6/5   | 125                     | 250              |
| HLPP028043B    | 57600                          | 13.6/6   | 125                     | 280              |
| HLPP030043B    | 57600                          | 13.6/6   | 125                     | 300              |

For the braking resistor used for the machines of above 315 KW please contact the factory.

For the inverter of above 11KW to realize quick brake a braking unit must be added.

Note:

- 1: Please select the resistor value and operating frequency given by our company.
- 2: If it causes any damage to the inverter and other devices due to the use of any braking resistor and braking model group not supplied by our company, we will take no responsibility.
- 3: Be sure to consider the safety and ignitability of the environment when installing a braking resistor. The distance to the inverter should be at least 100 mm.
- 4: If it is necessary to change the resistor value and power value, please contact the local distributor.
- 5: In need of a braking resistor a separate order must be placed. Please contact the local distributor for details.

## XII. Appendices

### Appendix 1: Simple Examples of Application

#### 1. Disturbance Function (Generation of Triangle Wave)

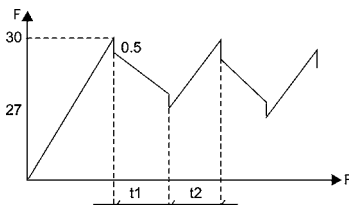

A curve as in left is generated.

Parameter setting:

CD076=3 CD000=30

CD080=27 CD086=0.5

CD087=10 CD088=10

#### 2. Drawing Function

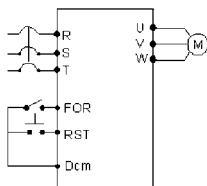
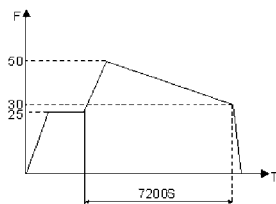

Parameter setting:

CD076=5 CD000=25 CD080=50 CD081=30

CD087=720 CD052=29 CD033=1

Note:

- ① When triggered by external multi-function terminals (as RST in the diagram), the drawing action starts to be implemented.
- ② In implementation of drawing action the running time  $T = CD087 \times 10S$

#### 3. FOR/REV Rotation of the Motor Controlled by One Potentiometer.

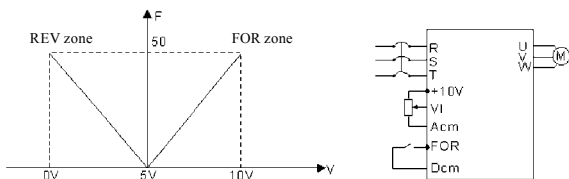

Parameter setting:

CD033=1 CD034=1 CD066=50 CD068=50

CD067=1 CD069=0 CD070=1

#### 4. Internal Control 8 Speed Run

A curve as shown in the following diagram is established. Internal control 8-speed run will stop after running for one cycle.

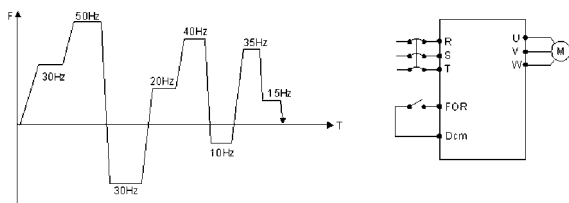

Parameter setting:

CD076=4 CD000=30 CD080=50 CD081=30

CD082=20 CD083=40 CD084=10 CD085=35

CD086=15 CD078=36 CD077=0 CD012=5

CD013=5 CD033=1 CD079=0 CD050=1

CD087-CD094=15

Note:

1. The running time of each speed is set by CD087-CD094=15.
2. Auto cycling CD077=1
3. After the running command is given it will run with the set curve for one cycle and stop.

## 5. Linkage of Multi Pumps

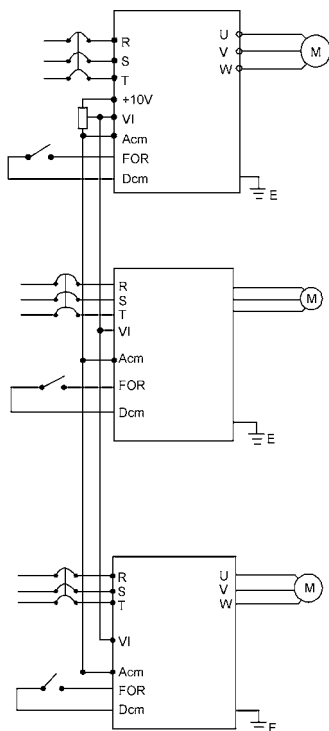

Attention:

① The frequency of the main inverter can be set by the potentiometer.

② The proportion relation of the inverters can be adjusted by CD068.

For example: For  $F_{\text{Inverter1}} : F_{\text{Inverter2}} : F_{\text{Inverter3}} = 1 : 2 : 3$  the parameters of CD068 can be adjusted.

Frequency 1: CD068=50, Frequency 2: CD068=100, Frequency 3: CD068=150. In case of the analog of 10V, the corresponding frequencies are respectively 50Hz, 100Hz, 150Hz with the proportion of .1: 2: 3.

③ For easy operation and adjustment a fine tuning potentiometer can be added. For concrete application please consult.

## 6. Run by Switching of Power Frequency/Variable Frequency

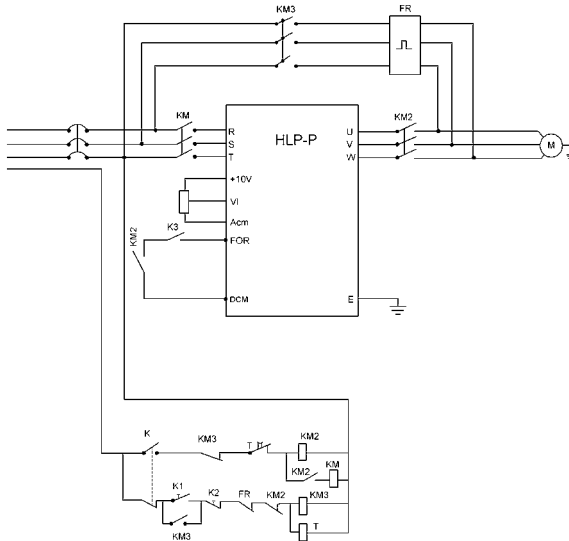

Note:

- ① K is a switch for power frequency/variable frequency.
- ② K<sub>1</sub> is a start button and K<sub>2</sub> is a stop button for power frequency.
- ③ The stopping mode is set for coasting stop.
- ④ K<sub>3</sub> is a start and stop button in variable frequency state.

## 7. Example application of simple water supply with constant pressure

(1) Use a pressure transmitter with measuring range of 0-10kg, feedback of 4-20mA, requiring water supply at the pressure of 5kg with alarming at the upper limit of 6kg and the lower limit of 4kg. The start from the panel stops.

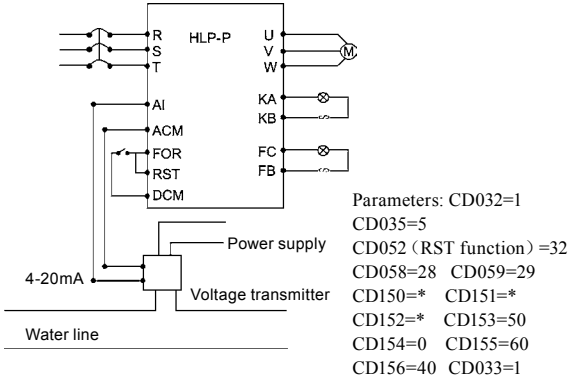

\* Note: CD150, CD151 and CD152 should be set according to the actual conditions. For general water supply with constant pressure, CD150=80~100, CD151=2.5~3, CD152=0.

(2) For a resistance transmission pressure gauge of 0~10kg it is required to control operation and stop by external terminals and give a target value through a potentiometer.

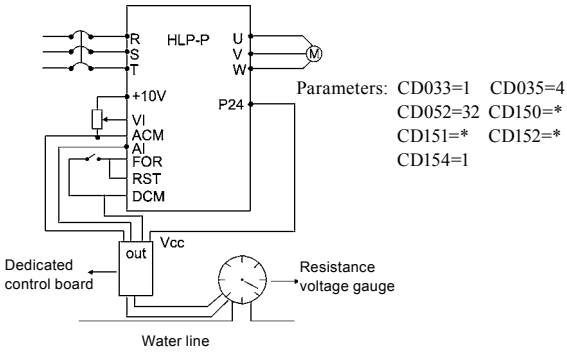

Attention:

① The target value of HLPP can be selected in two ways, one is to set it on the panel and another is the analog of 0~10V.

- ② The feedback signal is 4-20mA. Others are invalid.
- ③ In this example the target value is given by the potentiometer (0~10V).
- ④ CD150, CD151 and CD152 should be set according the actual condition. (Refer to the parameter description.)
- ⑤ The special panel for PID is designed according to general resistance transmission pressure gauge with input internal resistance converting to the standard signal in 0-400Ω. When the resistance value of the resistance transmission pressure gauge used by the customer exceeds the specified range please change the resistance transmission pressure gauge or connect a resistor in parallel for correction.
- ⑥ Output resistance values vary with different manufacturers of resistance transmission pressure gauge. After conversion the levels of current signal are different. The user can set a target value consistent with its actual conditions by themselves.

## 8. Example common application of analog and multi-speed:

Requirement: Speed 1 is given frequency by analog. Use a switch to switch it and turn to external control multi-speed run.

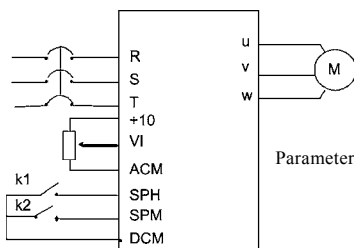

Parameters: CD034=1 CD076=2  
 CD053=20 CD054=21  
 CD080=15 CD081=30  
 CD082=25

Action Description:

①

| K1 State | K2 State | Operating Frequency      |
|----------|----------|--------------------------|
| OFF      | OFF      | Given by a potentiometer |
| ON       | OFF      | Speed 2 (15Hz)           |
| OFF      | ON       | Speed 3 (30Hz)           |
| ON       | ON       | Speed 4 (25Hz)           |

- ② The switching of forward and reverse rotation can be implemented through either multi-function terminals or the FOR/REV key on the panel. (In this example the switching is made through the panel)



## 9. Example application of Auto PLC Suspend

Requirement: Auto PLC can be suspended during the internal control multi-speed run. After handling the related problems it can resume.

### (1) Connection

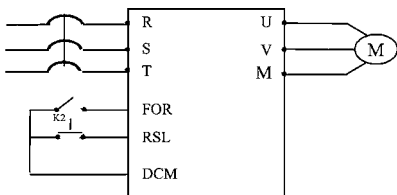

### (2) Parameter CD033=1, FOR terminal controls operation

CD055=31 SPL terminal is set for Auto PLC reset suspend function.

CD095=1 Auto PLC Memory CD077=1 Cycling run

CD076=4 Internal control multi-speed

CD080=15 CD084=20 CD082=25 CD000=10

CD087=10 CD088=10 CD089=10 CD090=10

### (3) Operating curve

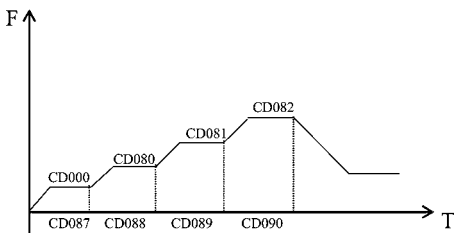

### (4) Operation description

① (K1) FOR is closed and the inverter will run according to the program set by internal control multi-speeds.

② When it is required to stop due to fault and process or other reasons, K1 will be opened. And the inverter will stop output and suspend counting time. After the fault is removed K1 will be closed and the inverter will continue to run according to original program.

③ When it is required to run again from the beginning due to fault and process stop K1 should be opened. Press K2 to reset. By closing K1 it will restart to run.

## Appendix 2: Appearance and Installation Dimensions

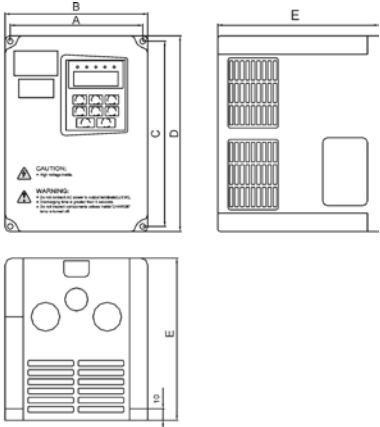
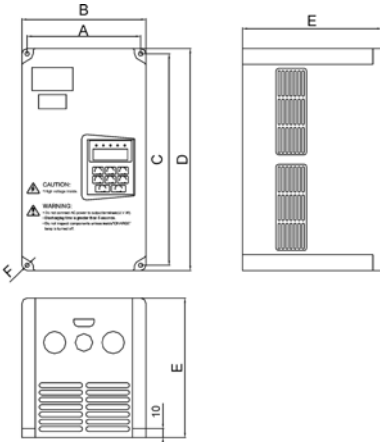
| Inverter Model  | Appearance and Installation Dimensions   |
|---|--|
| HLPP0D7523C<br>HLPP01D523C<br>HLPP02D223C<br>HLPP0D7543C<br>HLPP01D543C<br>HLPP02D243C<br>HLPP03D743C |  <p style="text-align: right;">Unit : mm</p>  |
| HLPP03D723B<br>HLPP05D523B<br>HLPP05D543B   |  <p style="text-align: right;">Unit : mm</p> |

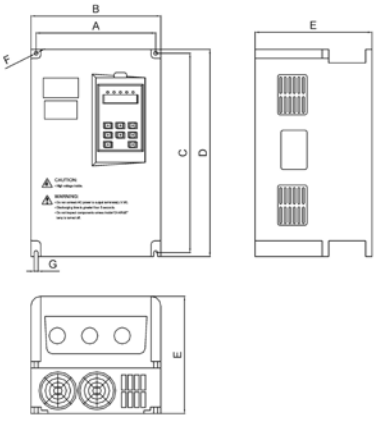
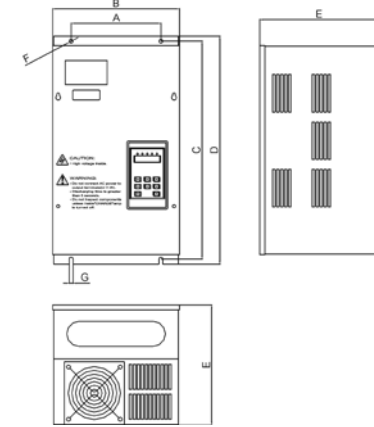
| Inverter Model                      | Appearance and Installation Dimensions   |
|-------------------------------------|--|
| <p>HLPP07D543B<br/>HLPP001143B</p>  |  <p style="text-align: right;">Unit : mm</p>  |
| <p>HLPP001543B~<br/>HLPP007543B</p> |  <p style="text-align: right;">Unit : mm</p> |

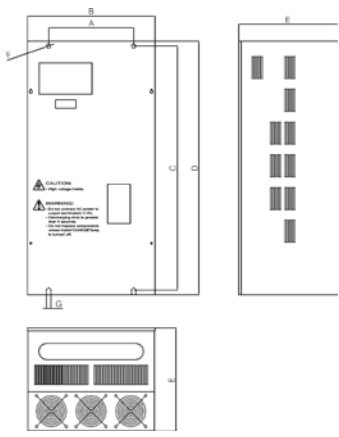
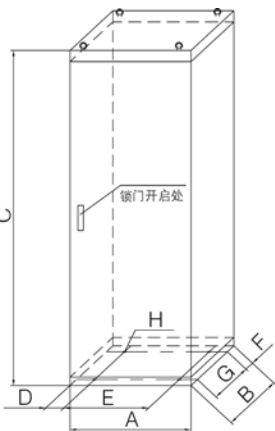
| Inverter Model   | Appearance and Installation Dimensions  |
|--|---|
| <p>HLPP009043B~<br/>HLPP018543B</p>                                    |  <p style="text-align: right;">Unit :mm</p>  |
| <p>HLPP016043BG~<br/>HLPP018543BG<br/>HLPP020043B~<br/>HLPP045043B</p> | <p>Height of 4 hoisting eyes :160~250KW 36mm<br/>280~450KW 43mm</p>  <p style="text-align: right;">Unit :mm</p> |

2. External Dimensions Table (Unit: mm)

| Inverter Model | A   | B   | C    | D   | E   | F   | G   | H   |
|----------------|-----|-----|------|-----|-----|-----|-----|-----|
| HLPP0D7523C    | 116 | 125 | 161  | 170 | 141 | Φ5  |     |     |
| HLPP01D523C    |     |     |      |     |     |     |     |     |
| HLPP02D223C    |     |     |      |     |     |     |     |     |
| HLPP0D7543C    |     |     |      |     |     |     |     |     |
| HLPP01D543C    |     |     |      |     |     |     |     |     |
| HLPP02D243C    |     |     |      |     |     |     |     |     |
| HLPP03D743C    |     |     |      |     |     |     |     |     |
| HLPP03D723B    | 128 | 140 | 238  | 250 | 157 | Φ5  |     |     |
| HLPP05D523B    |     |     |      |     |     |     |     |     |
| HLPP05D543B    |     |     |      |     |     |     |     |     |
| HLPP07D543B    | 184 | 200 | 306  | 318 | 180 | Φ6  | 6   |     |
| HLPP001143B    |     |     |      |     |     |     |     |     |
| HLPP001543B    | 182 | 257 | 437  | 457 | 242 | Φ8  | 8   |     |
| HLPP18D543B    |     |     |      |     |     |     |     |     |
| HLPP002243B    | 206 | 281 | 490  | 510 | 242 | Φ8  | 8   |     |
| HLPP003043B    |     |     |      |     |     |     |     |     |
| HLPP003743B    | 239 | 315 | 490  | 510 | 242 | Φ8  | 8   |     |
| HLPP004543B    | 250 | 345 | 650  | 670 | 325 | Φ10 | 10  |     |
| HLPP005543B    |     |     |      |     |     |     |     |     |
| HLPP007543B    |     |     |      |     |     |     |     |     |
| HLPP009043B    | 300 | 450 | 768  | 800 | 350 | Φ16 | 16  |     |
| HLPP011043B    | 300 | 450 | 828  | 860 | 350 | Φ16 | 16  |     |
| HLPP013243B    | 500 | 650 | 868  | 900 | 400 | Φ16 | 16  |     |
| HLPP016043B    |     |     |      |     |     |     |     |     |
| HLPP018543B    | 560 | 650 | 868  | 900 | 400 | Φ16 | 16  |     |
| HLPP016043BG   | 600 | 600 | 1649 | 90  | 420 | 90  | 400 | Φ16 |
| HLPP018543BG   |     |     |      |     |     |     |     |     |
| HLPP020043B    | 600 | 600 | 1805 | 90  | 420 | 90  | 400 | Φ16 |
| HLPP022043B    |     |     |      |     |     |     |     |     |
| HLPP025043B    |     |     |      |     |     |     |     |     |
| HLPP028043B    |     |     |      |     |     |     |     |     |
| HLPP030043B    |     |     |      |     |     |     |     |     |
| HLPP031543B    | 685 | 600 | 2225 | 90  | 505 | 90  | 400 | Φ16 |
| HLPP034543B    |     |     |      |     |     |     |     |     |
| HLPP037543B    |     |     |      |     |     |     |     |     |
| HLPP040043B    | 855 | 600 | 2279 | 90  | 675 | 90  | 400 | Φ16 |
| HLPP041543B    |     |     |      |     |     |     |     |     |
| HLPP045043B    |     |     |      |     |     |     |     |     |
| HLPP045043B    |     |     |      |     |     |     |     |     |

## Appendix 3: Appearance and Installation Dimensions

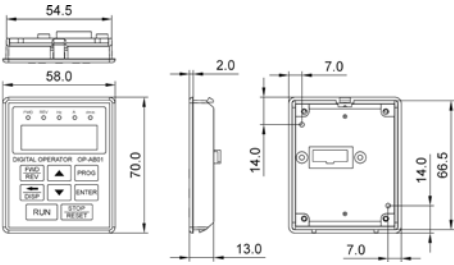
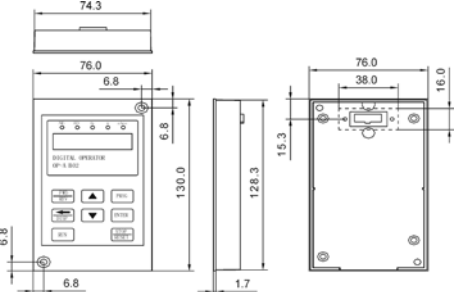
| Type               | Appearance and Installation Dimensions  |
|--------------------|---|
| OP-AB01<br>OP-AC01 |  <p>                         Front view dimensions: 54.5 (width of top section), 58.0 (width of main panel), 70.0 (height).<br/>                         Side view dimensions: 2.0 (thickness), 13.0 (bottom flange width).<br/>                         Back view dimensions: 7.0 (width of mounting holes), 14.0 (height of mounting holes), 66.5 (total height), 7.0 (width of bottom section).                     </p> <p style="text-align: right;">Unit : mm</p>  |
| OP-AB02            |  <p>                         Front view dimensions: 74.3 (width of top section), 76.0 (width of main panel), 6.8 (width of top section offset), 6.8 (width of main panel offset), 130.0 (height), 6.8 (width of bottom section offset).<br/>                         Side view dimensions: 128.3 (height), 1.7 (thickness).<br/>                         Back view dimensions: 76.0 (width of mounting holes), 38.0 (width of main panel), 16.0 (height of mounting holes), 15.3 (width of bottom section offset).                     </p> <p style="text-align: right;">Unit : mm</p> |

## Appendix 4: Description of Parameter Setting for HLP-A Inverter

### 1. Requirements:

Use a potentiometer to control the speed and a button to control starting or stopping of the inverter.

### 2. Setting requirements:

#### 1) Wiring

(1) 220V power supply, connecting to any two terminals of R, S, T, 3 $\phi$ 220 connecting to R, S, T terminals; 3 $\phi$ 380 connecting to R, S, T terminals, paying attention to the machine model. Do not mistake the inverters of 380V class and 220V class.

#### Special attention:

Connecting of the inverter of 220V class to 380 V class power will cause blowup of the inverter. The earth wire need to be connected separately to earth and must not be connected to zero line.

(2) U, V, W should be connected to the motor and the earth wire must be correctly (separately) connected to earth.

(3) The three ends of potentiometer are respectively connected to +10V, VI, ACM. Adjust the speed. VI terminal is connected to the center tap of potentiometer.

(4) External switches are connected to the terminals of FOR, DCM (Control operation).

#### 2) Wiring Diagram

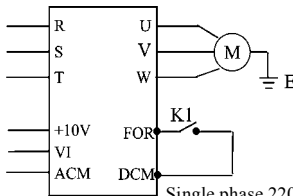

### 3) Parameter Setting

- (1) Turn on the power to display the version number, later 000.00;
- (2) Press Key "PROG" (Program) to enter to enter to programming status showing CD000;
- (3) Modify the parameter of CD033 to set the operation mode for the operation with external terminal. Press  $\Delta$  to reach CD033 or use  $\leftarrow$ ,  $\Delta$  to make the display reach CD033 (Note: Key  $\leftarrow$  is for shifting), and then press Key "SET" for confirmation. When 0 (i.e. content of CD033) is

displayed, press  $\Delta$  to change the value to “1” and press Key “SET” for confirmation. It will display END and later CD034. Other parameters can be set in the same way. After finishing setting, find PROG Key and return to the main menu to show the value for frequency.

(4) Other parameters setting:

CD033: 1 < External terminal control >

CD034: 1 < External potentiometer control >

CD050: 1 < FOR terminal is set to RUN, Close RUN, Open STOP >

Finally CD010=1, < Parameter Lock, i.e. lock the parameters. When it needs to be reset, first set CD010 to 0, i.e. unlock >

(5) Run operation

- ① When the external switch K1 is closed it runs;
- ② Adjust the knob of potentiometer for tuning the speed;
- ③ When the job is finished adjust the knob of potentiometer to zero;
- ④ Press K1 <Open >, the inverter stops;
- ⑤ Power off.

(6) Attentions:

- ① Both the power line and motor line must be correctly connected.
- ② During operating the power must be disconnected after the inverter stops.



## Appendix 5: User's Records and Feedback

| Code  | Function                                | Factory Setting             | User's Par. | Code            | Function                                     | Factory Setting | User's Par. |
|-------|---|-----------------------------|-------------|-----------------|--|-----------------|-------------|
| CD000 | Main Frequency                          | 0.00                        |             | CD087           | Timer 1                                      | 10.0            |             |
| CD001 | Max. Voltage                            | 220/380<br>acc. to<br>model |             | CD088           | Timer 2                                      | 10.0            |             |
| CD002 | Base Frequency                          | 50.00                       |             | CD089           | Timer 3                                      | 0.0             |             |
| CD003 | Voltage at<br>Intermediate<br>Frequency | *                           |             | CD090           | Timer 4                                      | 0.0             |             |
| CD004 | Intermediate<br>Frequency               | 2.50                        |             | CD091           | Timer 5                                      | 0.0             |             |
| CD005 | Voltage at Min.<br>Frequency            | *                           |             | CD092           | Timer 6                                      | 0.0             |             |
| CD006 | Min. Frequency                          | 0.50                        |             | CD093           | Timer 7                                      | 0.0             |             |
| CD007 | Max. Operating<br>Frequency             | 50.00                       |             | CD095           | AutoPLC<br>Memory                            | 0               |             |
| CD008 | Reserved                                |                             |             | CD096~<br>CD109 | Reserved                                     |                 |             |
| CD009 | Frequency<br>Lower Limit                | 0.00                        |             | CD110           | Number of<br>Auxiliary<br>Pump               | 0               |             |
| CD010 | Parameter Lock                          | 0                           |             | CD111           | Continuous<br>Operating Time<br>of Aux. Pump | 60              |             |
| CD011 | Parameter Reset                         | 00                          |             | CD112           | Interlocking<br>Time of Aux.<br>Pump         | 5.0             |             |
| CD012 | Accel. Time 1                           | *                           |             | CD113           | High Speed<br>Running Time                   | 60              |             |
| CD013 | Decel. Time 1                           | *                           |             | CD114           | Low Speed<br>Operating<br>Time               | 60              |             |
| CD014 | Accel. Time 2                           | *                           |             | CD115           | Stopping<br>Voltage Level                    | 95%             |             |
| CD015 | Decel. Time 2                           | *                           |             | CD116           | Lasting Time<br>of Stopping<br>Voltage Level | 30              |             |
| CD016 | Accel. Time 3                           | *                           |             | CD117           | Wakeup Time                                  | 80%             |             |
| CD017 | Decel. Time 3                           | *                           |             | CD118           | Sleep<br>Frequency                           | 20.00           |             |
| CD018 | Accel. Time 4                           | *                           |             | CD119           | Sleep<br>Frequency<br>Time                   | 20              |             |

| Code            | Function                      | Factory Setting | User's Par. | Code            | Function   | Factory Setting | User's Par. |
|-----------------|-------------------------------|-----------------|-------------|-----------------|--|-----------------|-------------|
| CD019           | Decel. Time 4                 | *               |             | CD120           | Over-voltage Stall Prevention                      | 1               |             |
| CD020<br>~CD029 | Reserved                      |                 |             | CD121           | Stall Prevention Level at ramp-up                  | 150             |             |
| CD030           | Reserved                      |                 |             | CD122           | Stall Prevention Level at Constant Speed           | 0               |             |
| CD031           | Starting Mode                 | 0               |             | CD123           | Stall Prevention Level at Deceleration             | 0               |             |
| CD032           | Stopping Mode                 | 0               |             | CD124           | Over-torque Detect Mode                            | 0               |             |
| CD033           | Source of Run Commands        | 0               |             | CD125           | Over-torque Detect Level                           | 0               |             |
| CD034           | Source of Operating Frequency | 0               |             | CD126           | Over-torque Detect Time                            | 1.0             |             |
| CD035           | Carrier Frequency             | *               |             | CD127           | Decel. Time for Stall Prevention at Constant Speed | 5.0             |             |
| CD036           | Jogging Frequency             | 5.00            |             | CD128           | Fault Restart Time                                 | 1.0             |             |
| CD037           | Rev Rotation Select           | 1               |             | CD129           | Voltage Rise Time during frequency track           | 0.5             |             |
| CD038           | STOP Key Select               | 1               |             | CD130           | Rated Motor Voltage                                | *               |             |
| CD039           | S-Curve Time                  | 0.0             |             | CD131           | Rated Motor Current                                | *               |             |
| CD040           | Up/down                       | 0.01            |             | CD132           | Motor Pole Number                                  | 04              |             |
| CD041           | Starting Frequency            | 0.50            |             | CD133           | Rated Motor Revolution                             | 1440            |             |
| CD042           | Stopping Frequency            | 0.50            |             | CD134           | Motor No-load Current                              | 40              |             |
| CD043           | Auto Torque Compensation      | 2.0             |             | CD135           | Motor Slip Compensation                            | 0               |             |
| CD044           | Skip Frequency 1              | 0.00            |             | CD136~<br>CD139 | Reserved   |                 |             |
| CD045           | Skip Frequency 2              | 0.00            |             | CD140           | DC Braking Voltage Level                           | 2.0             |             |

| Code  | Function                | Factory Setting | User's Par. | Code            | Function                          | Factory Setting | User's Par. |
|-------|-------------------------|-----------------|-------------|-----------------|-----------------------------------|-----------------|-------------|
| CD046 | Skip Frequency 3        | 0.00            |             | CD141           | DC Braking Time at start          | 0.0             |             |
| CD047 | Skip Frequency Range    | 0.50            |             | CD142           | DC Braking Time at stop           | 0.0             |             |
| CD048 | Timer 1 time            | 0.1             |             | CD143           | Frequency Track Time              | 5.0             |             |
| CD049 | Timer 2 time            | 1               |             | CD144           | Current Level for Frequency Track | 150             |             |
| CD050 | Multi-input 1 (FOR)     | 02              |             | CD145           | Restart after Instantaneous Stop  | 0               |             |
| CD051 | Multi-input 2 (REV)     | 03              |             | CD146           | Allowable Power-Breakdown Time    | 0.5             |             |
| CD052 | Multi-input 3 (RST)     | 10              |             | CD147           | Number of Abnormal Restart        | 0               |             |
| CD053 | Multi-input 4 (SPH)     | 17              |             | CD148           | Auto Voltage Regulation           | 1               |             |
| CD054 | Multi-input 5 (SPM)     | 18              |             | CD149           | Auto Energy Saving                | 0               |             |
| CD055 | Multi-input 6 (SPL)     | 19              |             | CD150           | Proportional Constant (P)         | 100%            |             |
| CD056 | Multi-output 1          | 01              |             | CD151           | Integral Time (I)                 | 5.0S            |             |
| CD057 | Multi-output 2          | 05              |             | CD152           | Differential Time (D)             | 0               |             |
| CD058 | Multi-output 3          | 02              |             | CD153           | Target Value                      | 0               |             |
| CD059 | Multi-output 4          | 00              |             | CD154           | PID Target Value                  | 0               |             |
| CD060 | Multi-output 5          | 0               |             | CD155           | PID Upper limit                   | 100             |             |
| CD061 | Uniform Frequency 1     | 0.00            |             | CD156           | PID Lower Limit                   | 0               |             |
| CD062 | Uniform Frequency 2     | 0.00            |             | CD157~<br>CD159 | Reserved                          |                 |             |
| CD063 | Uniform Frequency Range | 0.50            |             | CD160           | Communication Addresses           | 00              |             |
| CD064 | Counting value set      | 00              |             | CD161           | Communication Baud Rate           | 1               |             |
| CD065 | Analog Input            | 0               |             | CD162           | Communication Data Method         | 0               |             |

| Code  | Function                           | Factory Setting | User's Par. | Code            | Function                     | Factory Setting | User's Par. |
|-------|------------------------------------|-----------------|-------------|-----------------|------------------------------|-----------------|-------------|
| CD066 | Lower Analog Frequency             | 0.00            |             | CD163~<br>CD166 | Reserved                     |                 |             |
| CD067 | Bias Direction at Lower Frequency  | 0               |             | CD167           | Display Items                | 0               |             |
| CD068 | Higher Analog Frequency            | 50.00           |             | CD168           | Display Items Open           | 0               |             |
| CD069 | Bias Direction at Higher Frequency | 0               |             | CD169           | Voltage Rating of Inverter   | *               |             |
| CD070 | Analog Negative Bias Reverse       | 0               |             | CD170           | Rated Current of Inverter    | *               |             |
| CD071 | AM Analog Output Gain              | 100             |             | CD171           | Software Version             | *               |             |
| CD072 | Up/Down Function                   | 0               |             | CD172           | Fault Record 1               | ---             |             |
| CD073 | Up/Down Speed                      | 0               |             | CD173           | Fault Record 2               | ---             |             |
| CD074 | Analog Filtering Constant          | 20              |             | CD174           | Fault Record 3               | ---             |             |
| CD075 | Intermediate Counter               | 0               |             | CD175           | Fault Record 4               | ---             |             |
| CD076 | PLC Operation                      | 0               |             | CD176           | Fault Clear                  | 00              |             |
| CD077 | Auto PLC                           | 0               |             | CD177           | Inverter Model               |                 |             |
| CD078 | PLC Rotation Direction             | 0               |             | CD178           | Inverter Frequency Standards | 0               |             |
| CD079 | PLC Ramp Time                      | 0               |             | CD179           | Manufacture Date             | *               |             |
| CD080 | Frequency 2                        | 15.00           |             | CD180           | Serial No.                   | *               |             |
| CD081 | Frequency 3                        | 20.00           |             | CD181~<br>CD250 | Reserved                     |                 |             |
| CD082 | Frequency 4                        | 25.00           |             |                 |                              |                 |             |
| CD083 | Frequency 5                        | 30.00           |             |                 |                              |                 |             |
| CD084 | Frequency 6                        | 35.00           |             |                 |                              |                 |             |
| CD085 | Frequency 7                        | 40.00           |             |                 |                              |                 |             |
| CD086 | Frequency 8                        | 0.50            |             |                 |                              |                 |             |